

STRUCTURAL

**PRESSURE VESSEL
LIFTING,
HANDLING &
INSTALLATION
INSTRUCTIONS**



ContentsPage

Receiving3

Basic Handling Rules4

Approved Lifting Methods8

Installing Pressure Vessel with Fiberglass Base .10

Flange Cover Assembly and Torque Ratings12

Side Flange Support Strength14

UV Protection15

Vacuum Protection Flex Connectors16

Flexibility in Piping17

Vertical Base Removal and Replacement19

Install the New Base21

RECEIVING

Pressure vessels from Structural are protected during shipment by custom-size cradle skids. All pressure vessels are placed horizontally on the skid.

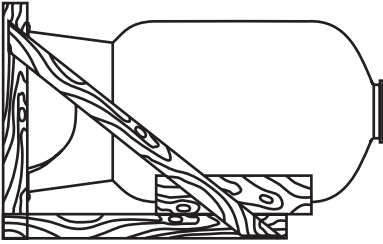

A pressure vessel with an integral **Fiberglass base** should be placed in a **vertical** upright position before removing its skid.

BASIC HANDLING RULES

This guide is designed to help install pressure vessels properly. Improper handling or installation can result in damage or pressure vessel failure.

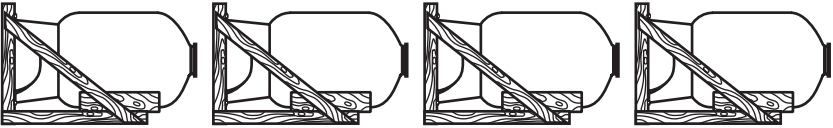

- 1.** If pressure vessels are being stored prior to installation, leave them in their **protective shipping skid** until ready to install.



- 2.** Never roll or slide a pressure vessel on its side.

-
- 3.** Never drop a pressure vessel or allow **hard impact or abrasion** of the pressure vessel from contact with walls, partitions, tools, or equipment.



- 4.** Lift the pressure vessel using a **crane or forklift** and the approved methods shown on pages 8 and 9.

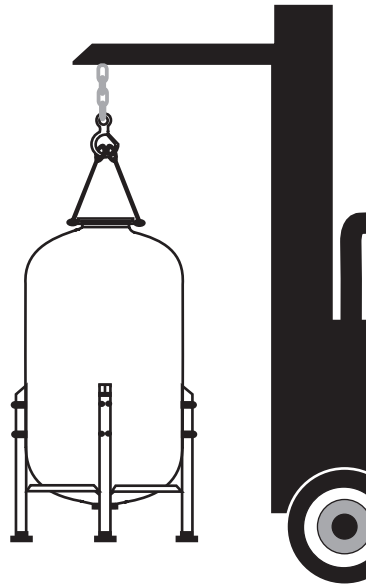

BASIC HANDLING RULES

continued



- 5.** Operators of hoist equipment must follow **proper rigging** procedures.



- 6.** Avoid use of hooks or equipment on the **inside** of the pressure vessel.

-
- 7.** Set rigging to lift from the **outside**, otherwise the lining could be damaged.

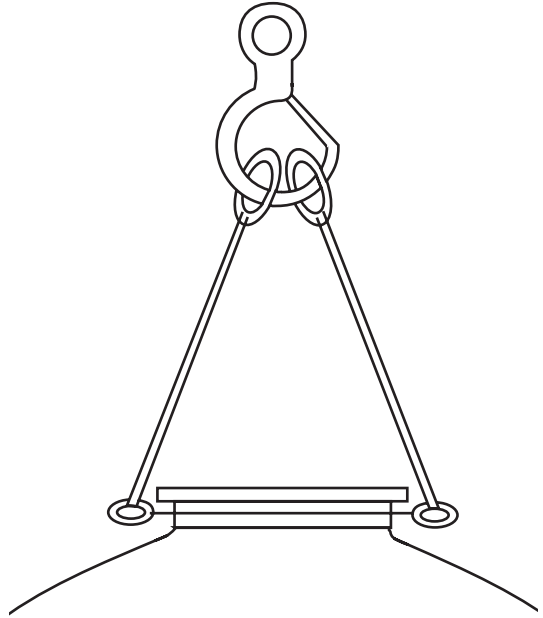

- 8.** **Never** fasten **cables or chains** around pressure vessel. Use canvas or nylon straps to avoid damage to the flange area.

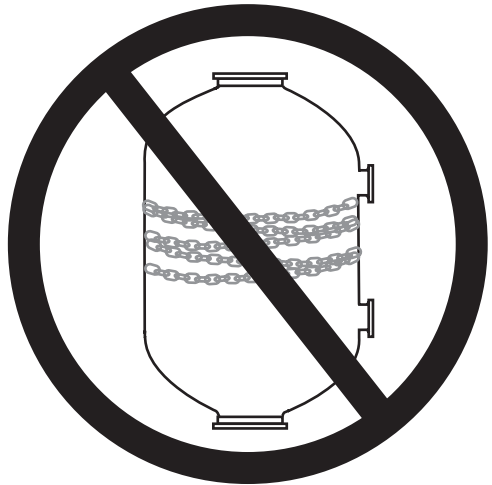

APPROVED LIFTING METHODS

By Flange

The empty pressure vessel is lifted by placing a user-supplied, webbed nylon reinforced sling, Penco, or rated steel cable around the top flange. Sling must be rated at minimum of 10,000 lbs. (4,500 kg).

CAUTION: Steel cable must have protective coating to prevent scratching of the flange's Teflon coating.

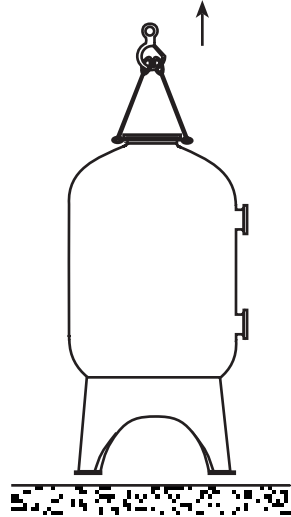

By Lift Strap

Attach a 1/2" (12.7 mm) thick, user-supplied steel lift strap to the top flange, using at least two (2) holes per side. Then connect to a rated (10,000 lbs.; 4,500 kg min.) eyehook and cable.

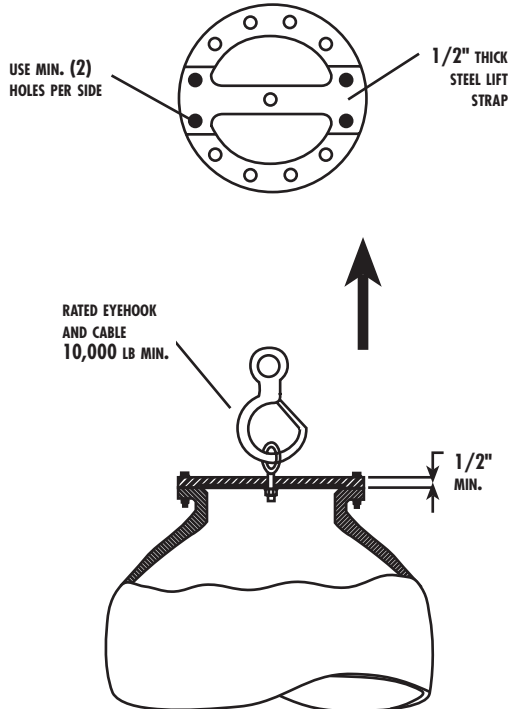

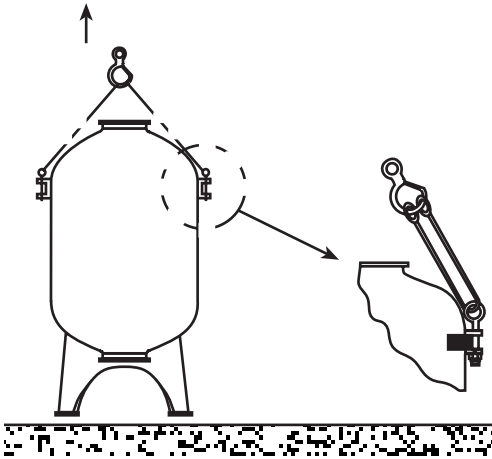

By Lifting Lugs

Bolt lifting eyes to the pressure vessel's integral lifting lugs (if specified) and attach a rated (10,000 lbs.; 4,500 kg) steel cable to the eyes.

CAUTION: Protect the flange's protective coating from being scraped by the cables.

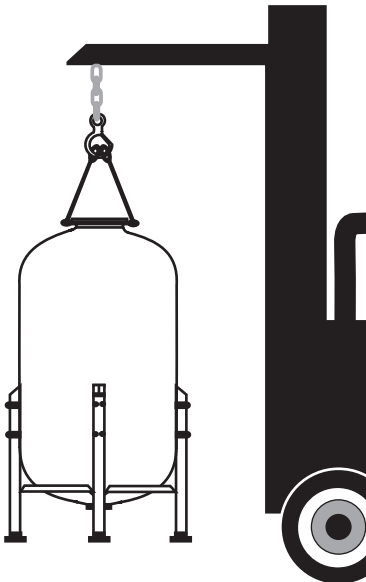

By Forklift

When unloading and installing a pressure vessel with I-Beam base, the pressure vessel may be lifted using a forklift unit.

CAUTION: Use only the approved sling rig methods; do not place chain or cable around or inside pressure vessel. Be sure forklift is designed to handle the pressure vessel's weight at the height the pressure vessel is to be lifted above the floor.

INSTALLING PRESSURE VESSEL WITH FIBERGLASS TRIPOD OR SKIRT BASE

To prevent breakage of the Fiberglass base, the following procedure is recommended for handling, unloading, and installing these pressure vessel types.

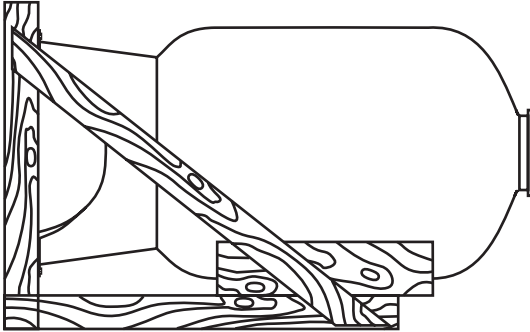

- 1.** When delivered, the pressure vessel and skid may be in a horizontal position. The first step is to **stand the whole assembly upright.** All precaution described earlier should be observed to protect the pressure vessel from damage.

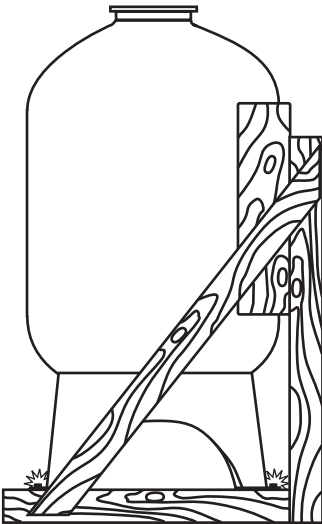

- 2.** When the pressure vessel and skid are upright, **remove the lag bolts** which are holding the skid to the base of the pressure vessel.

- 3.** Using one of the approved lifting methods shown on pages 8 & 9, **lift the pressure vessel** from the skid, and **remove the skid**.

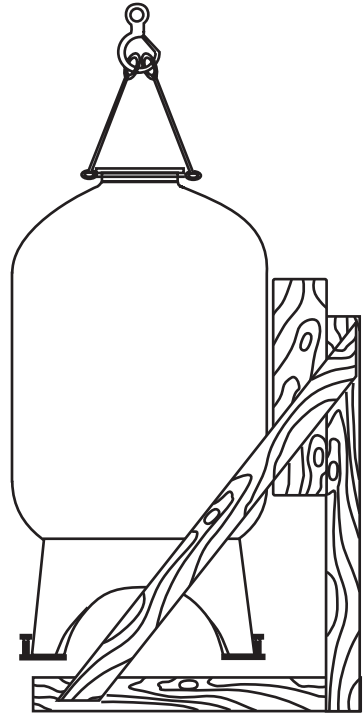

- 4.** Lower the pressure vessel to the floor, **level** the pressure vessel, and **anchor** it with 3/8" lag bolts to floor.

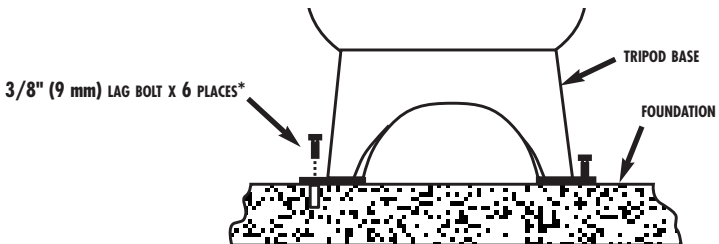

* BOLTS AND ANCHORS SUPPLIED BY CUSTOMER. (IT IS SUGGESTED THAT THE ANCHORS BE LOCATED AFTER THE PRESSURE VESSEL IS IN PLACE.)

FLANGE COVER ASSEMBLY AND TORQUE RATINGS

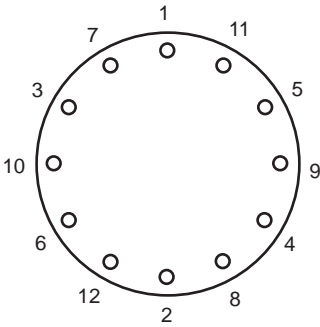

12-bolt Flange Cover (6", 152 mm Flange)
Tightening Sequence for 5/16" (7.9 mm)
Stainless Steel Bolts
Torque to 11 ft.-lbs. (15 NM)

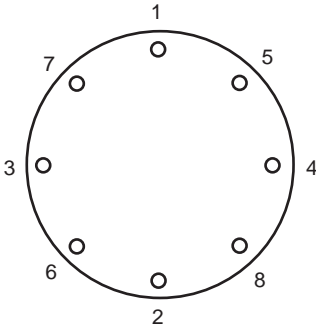

8-bolt Flange Cover (4-1/2", 114 mm
Flange)
Tightening Sequence for 3/4" (19 mm)
Stainless Steel Bolts
Torque to 130 ft.-lbs. (176 NM)

For All Vessels Larger than 24" Diameter

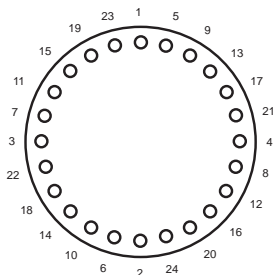

24-bolt Manway Flange Cover
 Tightening Sequence for 1/2" (12.7 mm)
 Stainless Steel Bolts
 Torque to 45 ft.-lbs. (61 NM)

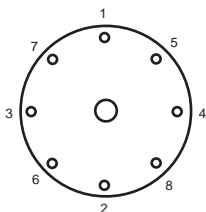

8-bolt, 4" (102 mm) ANSI Flange
 Tightening Sequence for 5/8" (15.9 mm)
 Stainless Steel Bolts
 Torque to 90 ft.-lbs. (122 NM)

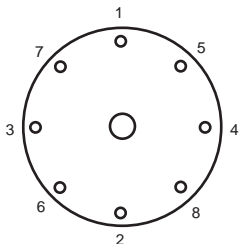

8-bolt, 6" (152 mm) ANSI Flange
 Tightening Sequence for 3/4" (19 mm)
 Stainless Steel Bolts
 Torque to 130 ft.-lbs. (176 NM)

TORQUE CHART

5/16" (7.9 mm) s/s* bolts = 11 ft. lbs. (15 NM)

3/8" (9.5 mm) s/s* bolts = 18 ft. lbs. (24 NM)

1/2" (12.7 mm) s/s* bolts = 45 ft. lbs. (61 NM)

5/8" (15.9 mm) s/s* bolts = 90 ft. lbs. (122 NM)

3/4" (19 mm) s/s* bolts = 130 ft. lbs. (176 NM)

* Stainless Steel

SIDE FLANGE SUPPORT STRENGTH

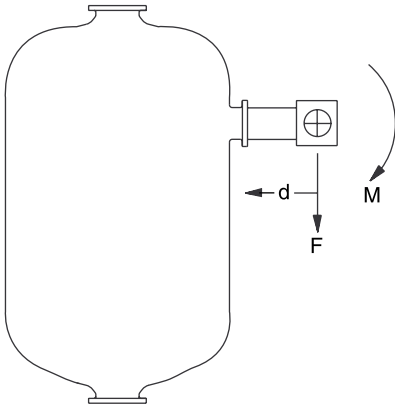

Valves, piping and hardware all contribute to the weight loads put on side flanges.

Side flanges are rated for a bending torque, M, maximum of 50 ft. lbs.

This means that:

$$d \times F \text{ must be } \leq 50 \text{ ft. lbs}$$

For $d = 1 \text{ ft.}$, $F_{\text{max.}} = 50 \text{ lbs.}$

Where $d =$ distance in feet from flange face to center of the load (such as a valve)

$F_{\text{max.}} =$ maximum support load in pounds

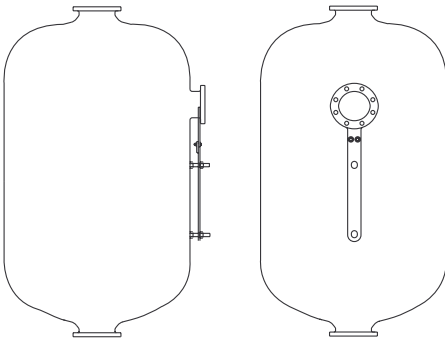

To support greater loads, a support kit, No. 12647, is available for upper side flanges only.

With the support kit, the side flange is rated for a bending torque, M, of 300 ft. lbs.

Thus, for $d = 1 \text{ ft.}$,
 $F_{\text{max.}} = 300 \text{ lbs.}$

Note: Lower side flanges not available when upper side flange support kit is used.

UV PROTECTION

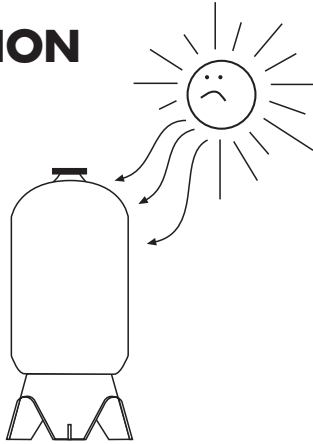

Painting a Composite Pressure Vessel for UV Protection

- 1.** Wash the pressure vessel with detergent and water, using a scrub brush. Use the brush actively over the pressure vessel surface to remove oil and grime.
- 2.** Rinse the pressure vessel several times with water to remove soap residue and let dry.
- 3.** Using a clean rag wetted with acetone, rinse the pressure vessel thoroughly with the acetone. Make sure that the rag does not become grimy, and use as much acetone as is practical to perform a “wet rinse” over the pressure vessel surface. **NOTE:** Acetone is extremely flammable. Should not be inhaled. Requires use of gloves.
- 4.** Spray paint or paint with a roller or brush.
- 5.** A 100% interior/exterior acrylic latex enamel is preferred. The paint has a good adhesion and will not chalk. This is a one-step paint with water clean-up. The 100% acrylic latex enamel can be purchased at a paint store.
- 6.** Coat the UV areas first, such as the top of the pressure vessel and the side, where sun rays directly hit the pressure vessel.
- 7.** A light-colored, pigmented paint is preferred. White paint is best.

VACUUM PROTECTION FLEX CONNECTORS

The pressure vessel is rated for an internal negative pressure of 5" Hg (17 Pa) vacuum below atmospheric. If negative pressure could ever exceed 5" Hg (17 Pa), an adequate vacuum breaker must be installed between the pressure vessel inlet and any valves, as shown here.

System connections to the pressure vessel must accommodate vertical expansion between side, top, and bottom openings. Either flexibility in piping, as shown on pages 22 and 23, or flex connectors as shown here, are recommended.

Flex connectors and Vacuum Breakers are available from Structural Please consult **accessory catalog**. Contact Customer Service; Tel: 440-286-4116

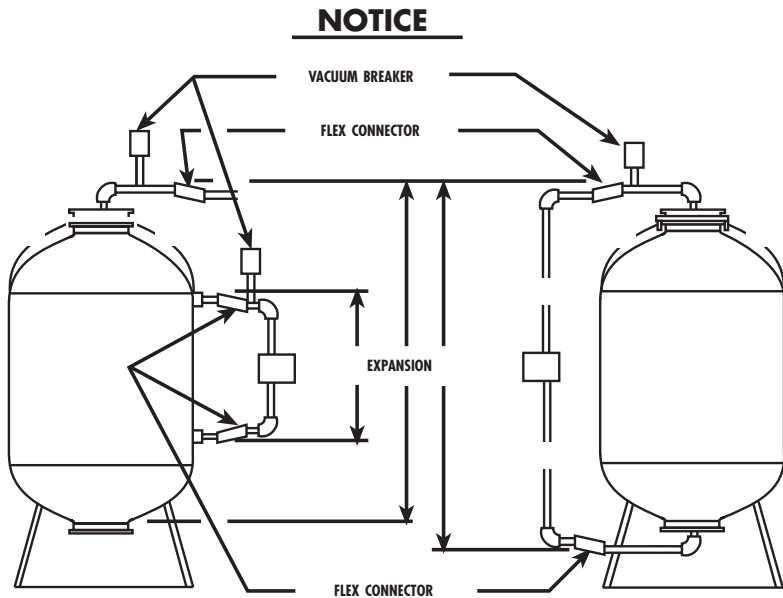

FLEXIBILITY IN PIPING

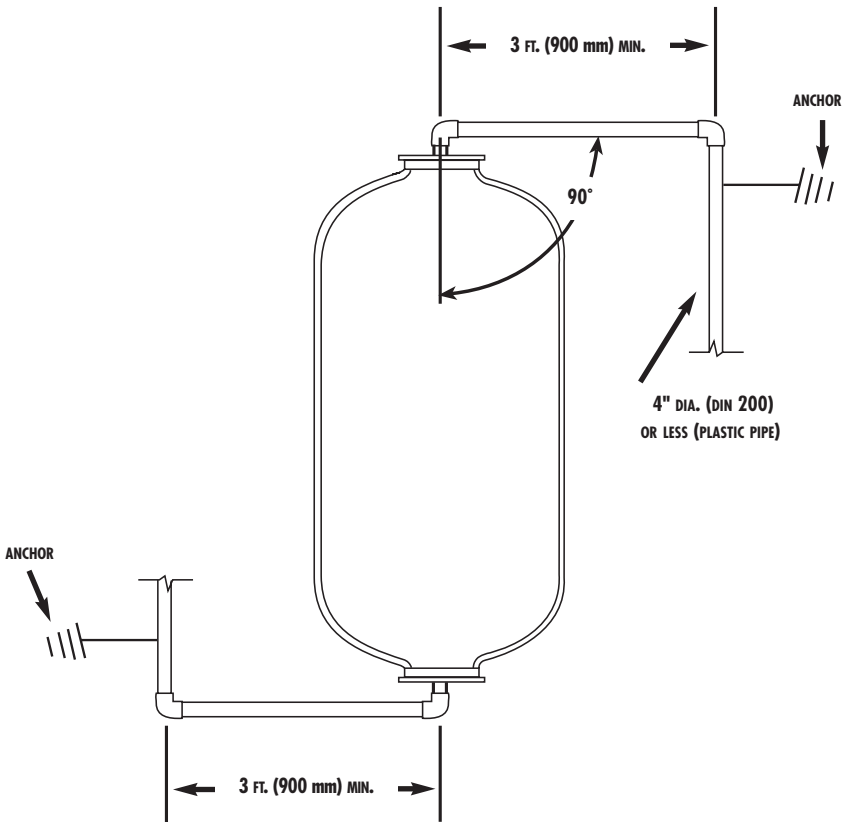

An effective alternative to flex connectors uses the inherent flexibility of right angle system design. By calculating the amount of cantilever overhang needed to absorb the torsional effect created by the pressure vessel's vertical movement, it is possible to build the needed flexibility right into the piping system. This can be done with both top/bottom and side flow piping setups.

FLEXIBILITY IN PIPING (continued)

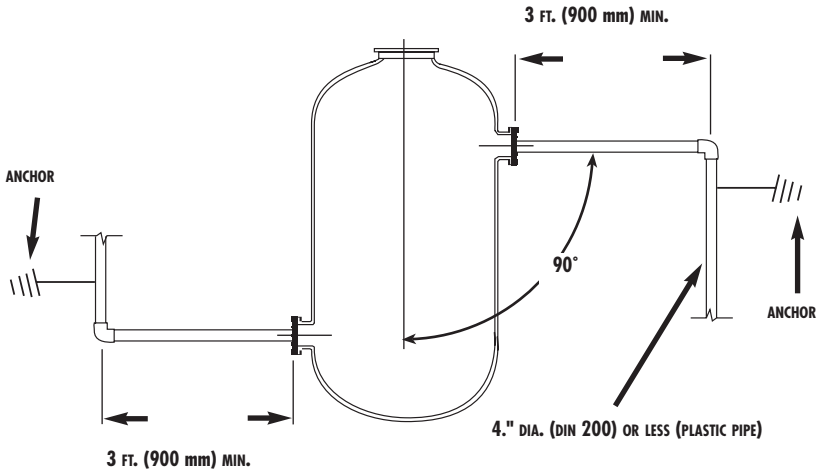

The figures shown here are the acceptable minimum for the pressure vessel at its rated pressure of 150 psig. When using the pressure vessel at a lower pressure, the minimum pipe run length can be reduced, using this formula:

- a. Multiply pressure vessel pressure in psi x 36
- b. Divide above by 150
- c. Result is minimum span of horizontal piping in inches

For example, if the pressure vessel pressure is 120 psi:

- a. $120 \times 36 = 4,320$
- b. $4,320 \text{ divided by } 150 = 28.8$
- c. Minimum span of horizontal piping is 29 inches

VERTICAL BASE REMOVAL AND REPLACEMENT

FOR:



TRIPOD

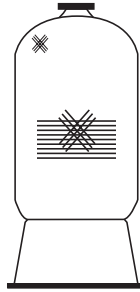

SHORT SKIRT



FRP SKIRT

REMOVAL KIT

A kit (#11644) with the required tools and instructions is available for purchase with the replacement base. The kit consists of wooden wedges (2), saw blades (3) with handle, adhesive (Bostic 1000), gloves, safety glasses and a rubber hammer.

REMOVAL

To remove the original base, the pressure vessel must be empty and in the horizontal position. The pressure vessel must be lying on a protective material, such as cardboard, to protect it.

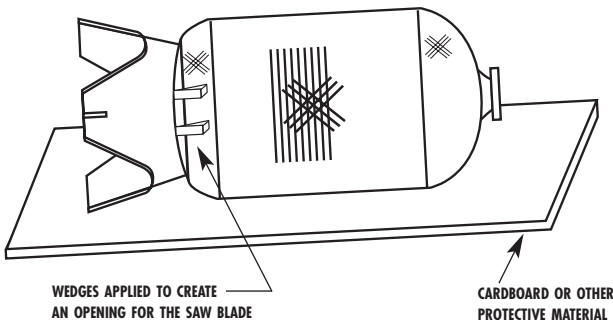

WEDGES APPLIED TO CREATE
AN OPENING FOR THE SAW BLADE

CARDBOARD OR OTHER
PROTECTIVE MATERIAL

NOTE: SAFETY GLASSES AND GLOVES MUST BE WORN FOR YOUR SAFETY

VERTICAL BASE REMOVAL AND REPLACEMENT (continued)

1. Drive a wooden wedge between the pressure vessel and the base with the rubber hammer to create an opening to insert the saw blade. If necessary, use the second wooden wedge to make an opening for the saw blade. Have the saw blade teeth toward your hand so that you cut the adhesive with a pulling motion rather than a pushing motion. **Use extreme caution** to avoid injury when performing this step.

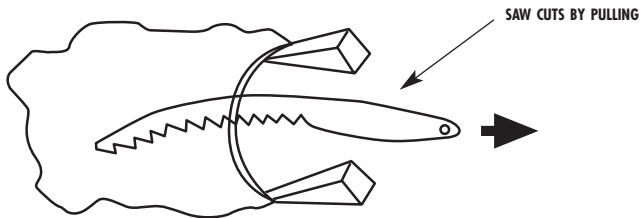

NOTE: **Use extreme caution** to avoid damaging fibers. If fibers are damaged, pressure vessel must **not** be used.

2. As the adhesive is being cut, the wedges must be moved (around the outer diameter of the base) to maintain a gap between the pressure vessel and the base to allow the saw blade to cut the adhesive without getting bound up.
3. After the base is removed, the heavy excess adhesive on the pressure vessel must be removed. Be careful. Do not damage exterior surface of the pressure vessel. It is not necessary to remove all of the old adhesive, but just the heavy excess to allow room for the fresh adhesive. Take your time, the base was installed for the life of the pressure vessel, so it may take a great deal of effort and patience to remove the old base without damaging the pressure vessel.

INSTALL THE NEW BASE

- 1.** You must first level the base on a concrete floor. The wooden wedges may need to be used under one or two of the tripod legs to get the base level if the floor is not level.

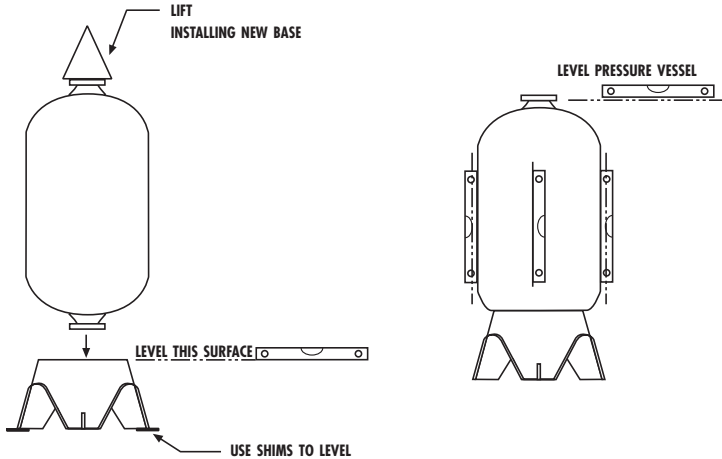

- 2.** The adhesive is applied to the base (with a caulking gun) in a pattern that duplicates the area covered on the old base. The tip of the adhesive tube must be cut to apply the adhesive in a 1/4" diameter minimum.
- 3.** The pressure vessel must be lifted vertically (see drawings on lifting options) and set down onto the base.
- 4.** Level the pressure vessel by using a level on at least 4 points around the outer diameter of the pressure vessel.
- 5.** Once you are satisfied that the pressure vessel is level, the pressure vessel must be allowed to set (undisturbed) for at least 8 hours.
- 6.** Install the pressure vessel.

BASIC HANDLING RULES



Never **roll or slide** a pressure vessel on its side.



Never **drop** a pressure vessel or allow **hard impact or abrasion** of the pressure vessel from contact with walls, partitions, tools, or equipment.



Hoist operators must follow **proper rigging** procedures.



Avoid use of hooks or equipment on the **inside** of the pressure vessel.



Never fasten **cables or chains** around pressure vessel. Use canvas or nylon straps to avoid damage to the flange area.

STRUCTURAL

The Leader in Composite Pressure Vessel Technology
Industrial Parkway • Chardon, OH 44024 U.S.A.
Tel: 440-286-4116