

Water Specialist WS2H, WS2HF, and WS3 Control Valve Manual

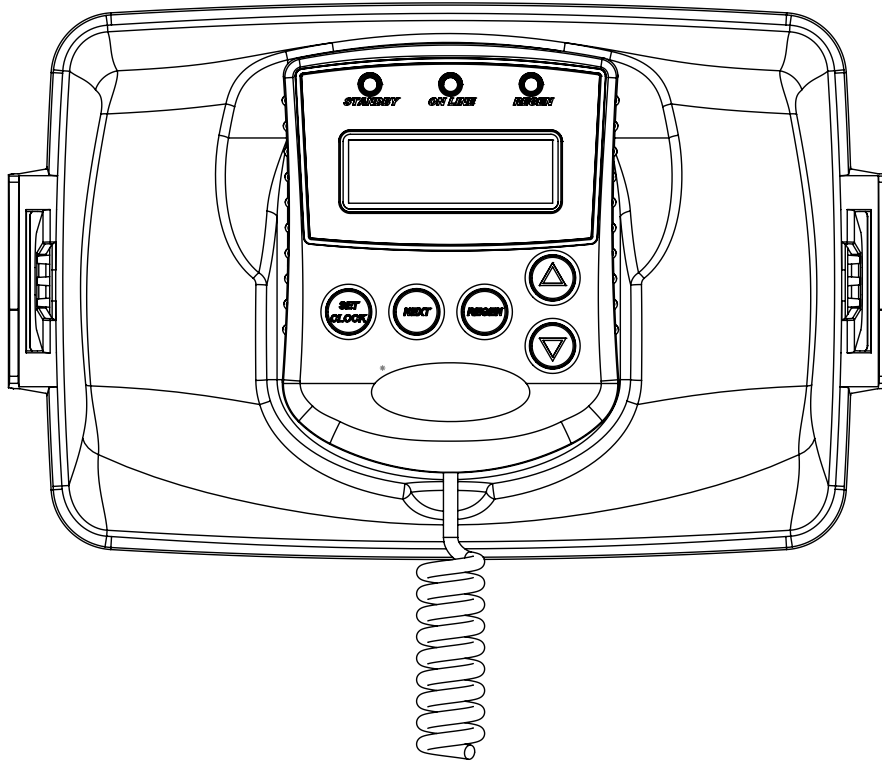

WARNING: USE ONLY SILICONE-BASED LUBRICANTS ON ALL CLACK CORPORATION COMPONENTS
HYDROCARBONS WILL DAMAGE COMPONENTS THAT CONTAIN O-RINGS AND/OR PLASTIC. THIS CAN CAUSE
LEAKS OR BREAKAGE. DO NOT USE LUBRICANTS THAT CONTAIN HYDROCARBONS SUCH AS VASELINE®/
PETROLEUM JELLY, WD-40®, ETC. DO NOT USE CLACK CONTROL VALVE PRODUCTS ON WATER SUPPLIES THAT
CONTAIN HYDROCARBONS, SUCH AS BENZENE, GASOLINE, KEROSENE, ETC.

TABLE OF CONTENTS

General Specifications and Pre-Installation Checklist	4
Wiring for Custom Power Adapter	5
Custom Meter Wiring	5
Main PC Board	6
Typical System Examples.....	7
Button Function and Programming Key Sequence.....	9
Programming Quick Reference	10
Typical User Screens.....	12
Setting Time of Day and Date	14
Notifications	14
Errors	14
Main Menu Screen	15
System Setup Screens.....	16
Cycle Setup Screens.....	21
Expansion Setup Screens	23
Installer Setup Screens	26
Diagnostic Screens	28
Valve History.....	31
Custom Motorized Drive Timing.....	32
Modbus Information.....	33
Installation	36
Installation Summary.....	41
Cycle Positions / Flow Diagrams.....	42
Front Cover and Drive Assembly.....	45
Drive Cap Assembly, Downflow Piston, Regenerant Piston, Spacer Stack Assembly, Drive Backplate and Main Body.....	46
Inline Flow Meter Assembly.....	47
WS2H, WS2HF, and WS3 Brine Valve Body and Injector Components.....	48
Standard Injector Graphs	49
Bases.....	51
Drain Line Flow Controls	52
WS2H, WS2HF, and WS3 Troubleshooting Guide	56

**GENERAL SPECIFICATIONS AND PRE-INSTALLATION CHECKLIST
TABLE 1**

Minimum/Maximum Operating Pressures	20 psi (138 kPa) -125 psi (862 kPa)		
Minimum/Maximum Operating Temperatures	40°F (4°C) – 110°F (43°C)		
Power Adapter: Supply Voltage Supply Frequency Output Voltage Output Current	U.S. and International 120/230 VAC 50/60 Hz 24 VDC (see Table 2) 800 mA		
No user serviceable parts are on the PC board, the motor, or the Power adapter. The means of disconnection from the main power supply is by unplugging the Power adapter from the wall.			
Service flow rate	WS2H Valve: 125 gpm (473 lpm, 28.4 m ³ /h) @ 15 psig (103 kPa) drop WS2HF Valve: 165 gpm (625 lpm, 37.5 m ³ /h) @ 15 psig (103 kPa) drop WS3 Valve: 250 gpm (946 lpm, 56.8 m ³ /h) @ 15 psig (103 kPa) drop		
Backwash flow rate	WS2H Valve: 125 gpm (473 lpm, 28.4 m ³ /h) @ 25 psig (172 kPa) drop WS2HF Valve: 175 gpm (662 lpm, 39.8 m ³ /h) @ 25 psig (172 kPa) drop WS3 Valve: 220 gpm (833 lpm, 50.0 m ³ /h) @ 25 psig (172 kPa) drop		
CV Service	WS2H Valve: 32.3 WS2HF Valve: 42.6 WS3 Valve: 64.6		
CV Backwash	WS2H Valve: 25.0 WS2HF Valve: 35.0 WS3 Valve: 44.0		
Meter: Accuracy: Flow Range:	WS2" Valves + 5 % 1.5 – 125 gpm (5.7 – 473 lpm)	WS3 Valve: Optional External Meter + 5 % 3.5 – 350 gpm(13.3 – 1325 lpm)	
Regenerant Refill Rate	Variable - Shipped from Factory with 2.2 gpm (8.33 lpm)		
Injectors	See Injector Graphs V3010-2A through 2H		
Brine Line Adapters Included	1" Male NPT Elbow & ¾" x 1" Solvent Weld Elbow		
Inlet, Outlet and Drain Line Openings	2" Valves: 2" Female NPT or BSPT 3" Valves: 3" Female NPT or BSPT		
*Distributor Tube Sizing:	Female NPT Inlet & Outlet		Female BSPT Inlet & Outlet
2" Valves	2.375" OD (2.0" NPS)	+2.25" - +2.5"	63 mm OD
3" Valves	3.5" OD (3" NPS)	+2.5" - 2.75"	90 mm OD
			+57 mm - +64 mm +64 mm - + 70 mm
Tank Connection: 2" Valves 3" Valves	4"-8UN, 6" Flange, Side Mount (2" Female NPT or BSPT) 6" Flange or Side Mount (3" Female NPT or BSPT)		
Shipping Weight	WS2H Valve with Meter: 50 lbs. (22.7 kg) WS2HF: 48 lbs. (21.8 kg) Meter Sold Separately WS3 Valve: 57 lbs. (25.9 kg) Meter Sold Separately		
PC Board Memory	Nonvolatile EEPROM (electrically erasable programmable read only memory)		
Compatible with the following typical concentrations of regenerants/chemicals	Sodium chloride, potassium chloride, potassium permanganate, sodium bisulfite, chlorine and chloramines		

*Height is based off the top of tank. Installer to verify proper engagement and allowance for tank expansion

WIRING FOR CUSTOM POWER ADAPTER

1. Cable should be one unshielded pair of 22AWG, UV resistant UL2464 compliant wire.
2. Connector details:
 - a. Terminate end with one Hirose black housing, P/N DF3-4S-2C and four Hirose pins, P/N DF3-22SC.
 - b. Pin 1 = Ground from power supply (Black)
 Pin 2 = Jumper to Pin 3
 Pin 3 = Jumper to Pin 2
 Pin 4 = 24 VDC from power supply (White)

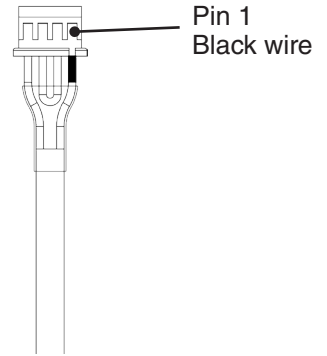

CUSTOM METER WIRING

- 1) Terminate end with a Molex series 2695 housing, part number 22-01-3037 and (3) Molex series 41572 (or 40445) pins, part number 08-65-0805 (or 97-00-44).
- 2) Auxilliary meter must be able to operate on 5VDC
 Pin 1 = +5 VDC
 Pin 2 (Center) = Signal
 Pin 3 = Ground
- 3) Acceptable pulse input is 0.1 – 999 pulses/gallon, or 0.4 –519 pulses / liter.

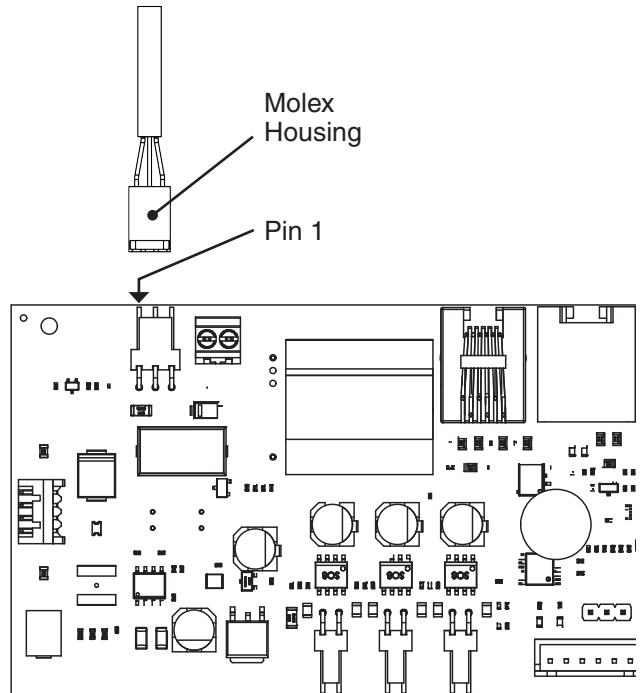

MAIN PC BOARD

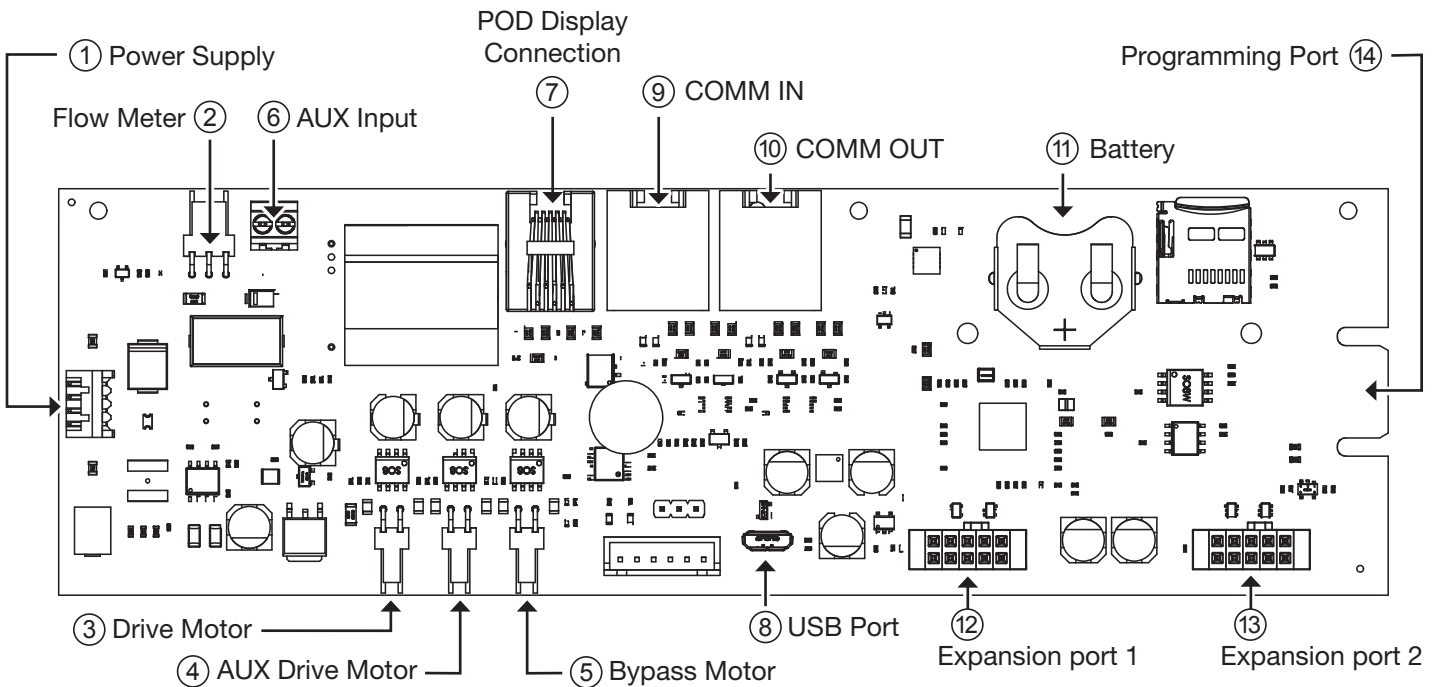

Item	Board label	Description
1	POWER	Connect to proper power supply
2	FLOW	Input for the unit's flow meter
3	REGEN	Motor circuit used to power the main drive of the unit during regeneration
4	AUX DRIVE	2nd Drive circuit for factory motorized isolating valve (MAV or NoHBP)
5	BYPASS	Drive circuit for factory motorized isolating valve (MAV or NoHBP)
6	AUX IN	Connect to external dry contacts to control functionality based on the unit's settings **Wiring units inputs in parallel requires matching each units polarity**
7	DISPLAY	Connection for POD display
8	USB	USB connection for future use. Must use adapter cable to convert from micro-USB connection to USB female adapter
9	COMM IN/MODBUS	RJ45 communication port for communication to LEAD or previous LAG. Must use straight through RJ45 cable with T-568B wiring for communication to LEAD or previous LAG. If setup as LEAD, can be used for Modbus communication with proper cable wiring and RS485 communication adapter.
10	COMM OUT	RJ45 communication port for communication to LAG units. Must use straight through RJ45 cable with T-568B wiring for communication to LAG.
11	BAT1	CR2032 battery for keeping clock powered during power loss
12	EXP1	Connection for the optional expansion boards
13	EXP2	Connection for the optional expansion boards
14	DATA	Factory use only

TYPICAL SYSTEM EXAMPLES

Twin Tank System, Simple Alternator (Sharing a MAV)

System consists of 2 power heads, 1 communication cable and 1 MAV

Electrical Connections:

- The MAV's motor wire is connected to the 2-pin connector labeled BYPASS on Unit 2 (Unit B) PC board
- Using a standard straight through RJ45 cable (T-568B wiring), connect the "COMM OUT" of the LEAD control to the "COMM IN" of the LAG control (See Page 6 for connector locations)
- If a single external meter is used, it should be connected to the 3-pin connector on Unit 2 (Unit B) labeled FLOW. NOTE: When using a single external meter, "SYSTEM PULSES" and the proper pulse rate must be selected in the programming section.

Plumbing Connections:

- To regenerate with raw/untreated water, the outlet of each unit is piped to the MAV. Port A will be piped to the LEAD (Unit A), Port B to the LAG (Unit B), and Port C to the common supply outlet.
- To regenerate with soft/treated water, the inlet of each unit is piped to the MAV. Port A will be piped to the LEAD (Unit A), Port B to the LAG (Unit B) and Port C to the common supply outlet.

If the piston rod is not visible, the current path of flow is between the "A" and "C" ports.

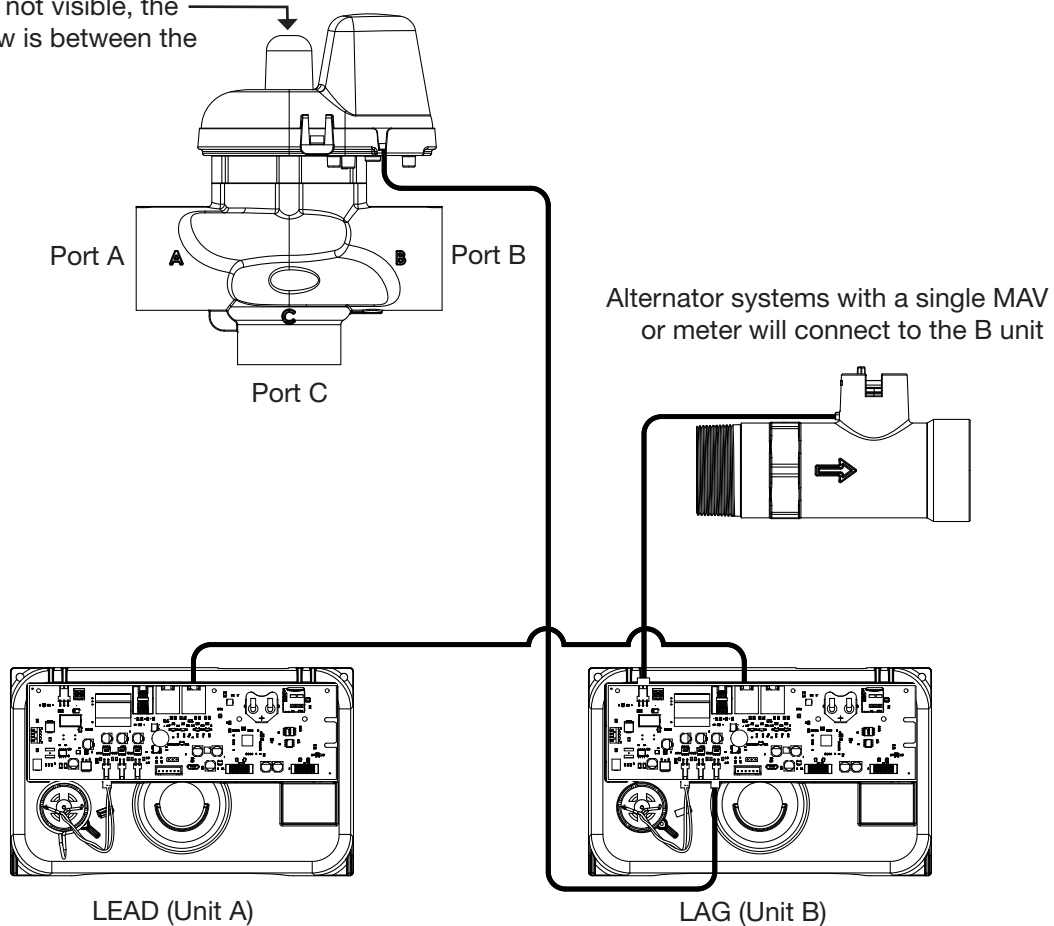

TYPICAL SYSTEM EXAMPLES (CONTINUED)

Multi-tank System, 3 Unit shown

System consists of 3 power heads, 2 communication cables and 3 No Hard Water Bypass (Isolation) valves

Electrical Connections:

- Each unit's isolation valve motor wire is connected to the 2-pin connector labeled BYPASS on each unit's PC board.
- Using two standard straight through RJ45 cables (T-568B wiring), connect the "COMM OUT" of the LEAD control to the "COMM IN" of LAG 1 and the "COMM OUT" of LAG 1 to the "COMM IN" of LAG 2 (See Page 6 for connector locations)

Plumbing Connections:

- To regenerate with raw/treated water, the isolation valve is piped into the outlet of each unit.
- To regenerate with soft/treated water, the isolation valve is piped into the inlet of each unit.

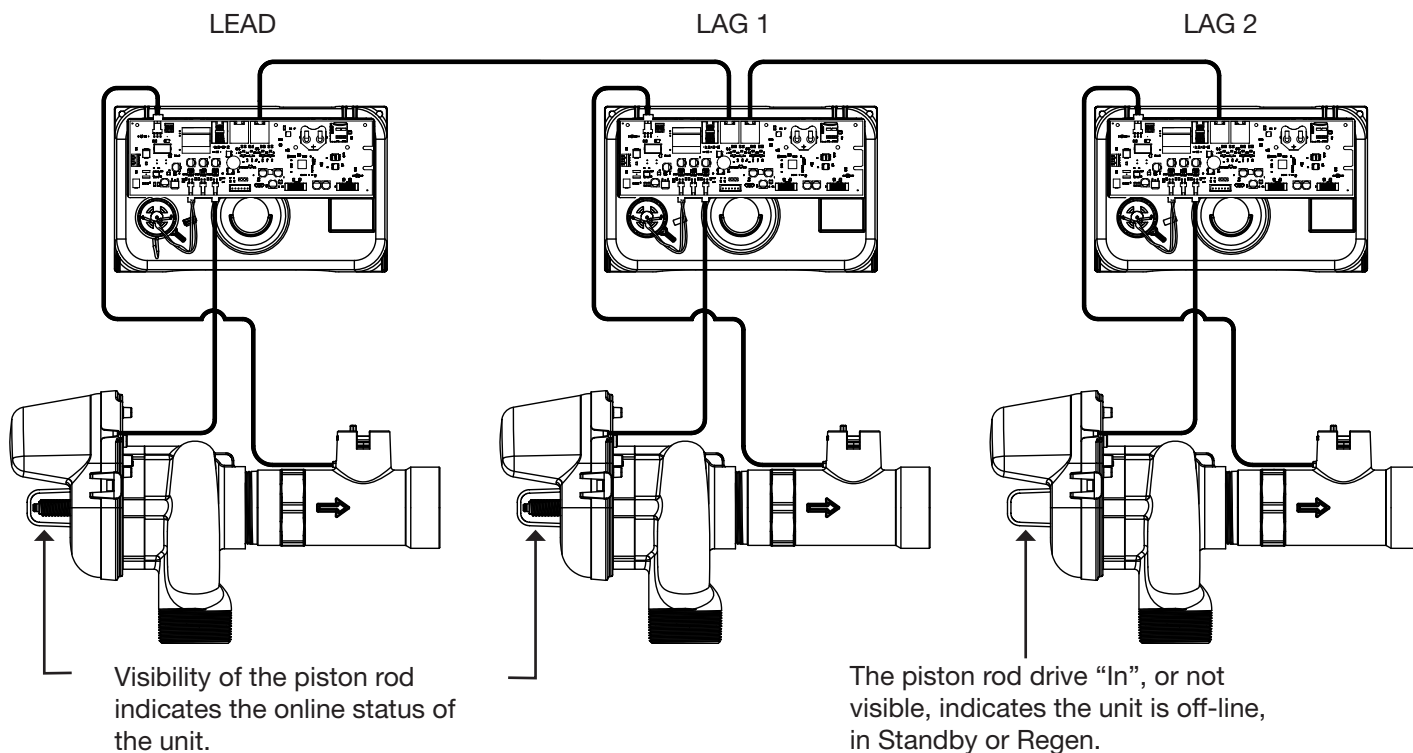

BUTTON FUNCTION AND PROGRAMMING KEY SEQUENCE

STANDBY

Standby LED

- Signals that a unit is not in service, or regen
- Flashes to alert status conditions
 - 1 per second indicates flow had been detected while the unit was off-line

ON LINE

Online LED

- Signals that a unit is currently in service

REGEN

Regen LED

- Signals that a unit is currently in regen

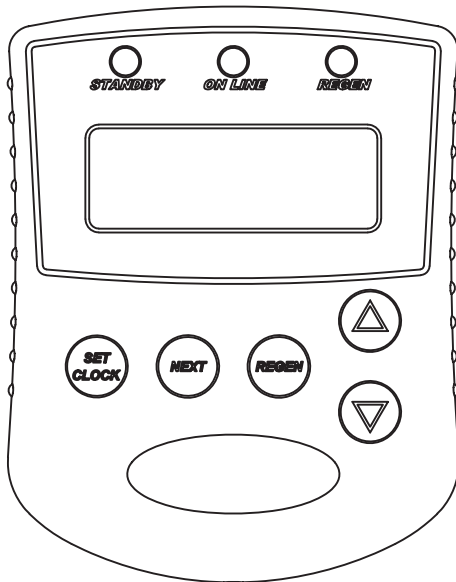

Set clock from User Screens
Exit & save from setup or program screens.



Move to the next display



Change variable being displayed



Toggles scheduled regen time on/off.
Holding for >3 sec. starts immediate regen (immediate regen is the only option if set to immediately regenerate upon 0 gallons).
Moves back one display while in program mode.



Reset
Holding for >3 seconds initiates a reset. The software version is shown and the piston returns to the "home" position, re-synchronizing the valve.



History Reset
Holding the Set Clock & Regen buttons for >3 seconds initiates a totalizer or history reset.



Key sequence to lock and unlock programming screens

Programming Key Sequences	
Programming Level	Buttons
Installer	Next Up
Main Setup Menu	Next Dn
Diagnostics and History	Up Dn

PROGRAMMING QUICK REFERENCE

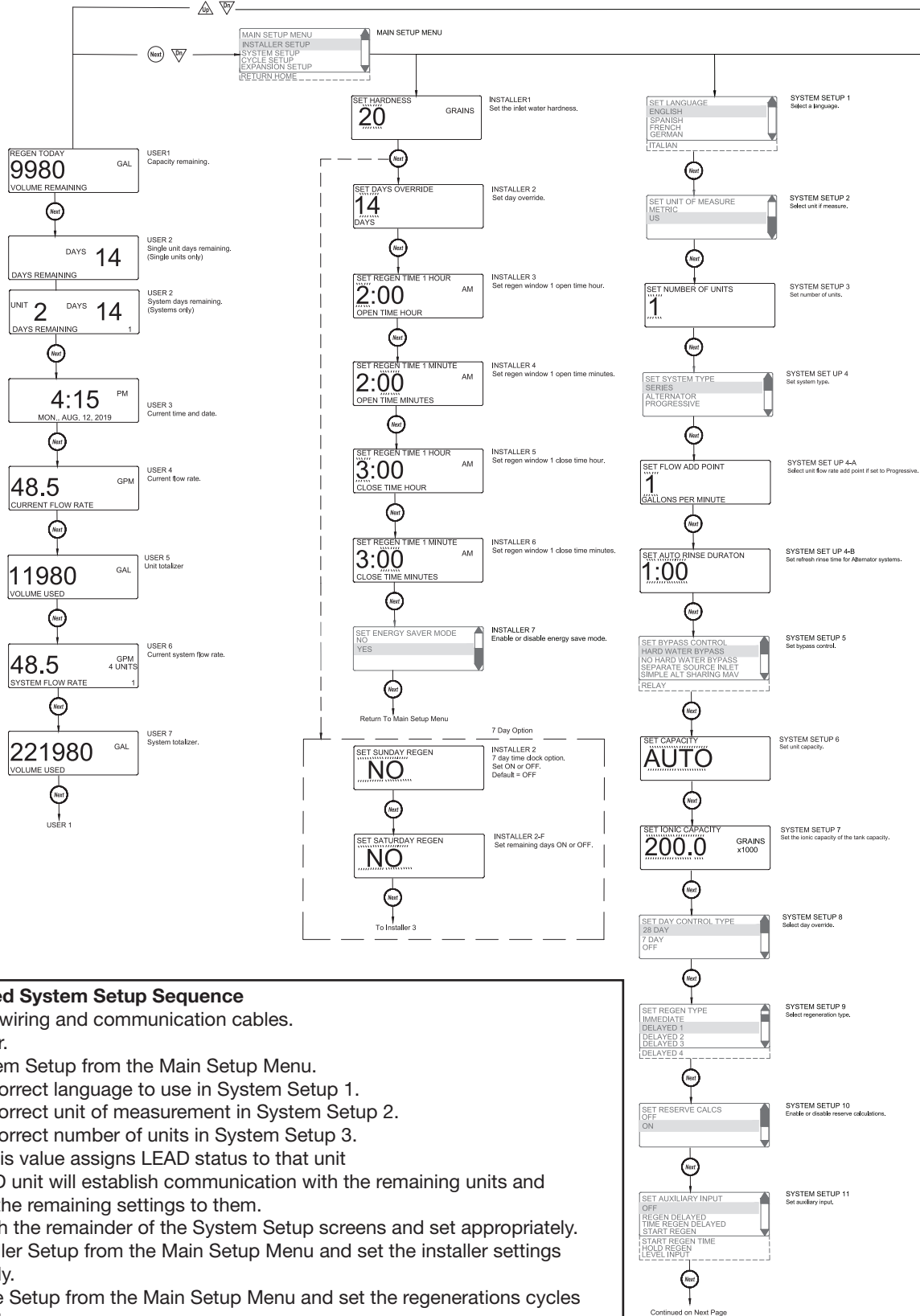

Recommended System Setup Sequence

1. Connect all wiring and communication cables.
2. Apply power.
3. Select System Setup from the Main Setup Menu.
4. Select the correct language to use in System Setup 1.
5. Select the correct unit of measurement in System Setup 2.
6. Select the correct number of units in System Setup 3.
 - a. Setting this value assigns LEAD status to that unit
 - b. The LEAD unit will establish communication with the remaining units and transfer the remaining settings to them.
7. Step through the remainder of the System Setup screens and set appropriately.
8. Select Installer Setup from the Main Setup Menu and set the installer settings appropriately.
9. Select Cycle Setup from the Main Setup Menu and set the regenerations cycles appropriately.
10. If using the relay board, select Expansion Setup from the Main Setup Menu and set the relays as needed.

WS2 Programming Screen Quick Reference

1. Individual screen descriptions and settings are detailed on the following pages.
2. Some screens have been omitted for clarity.

PROGRAMMING QUICK REFERENCE

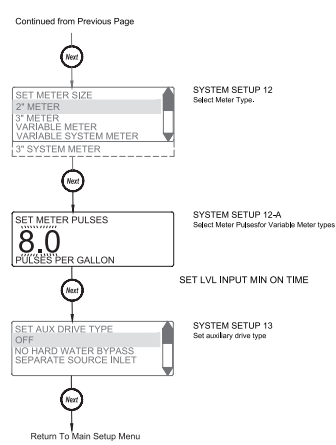
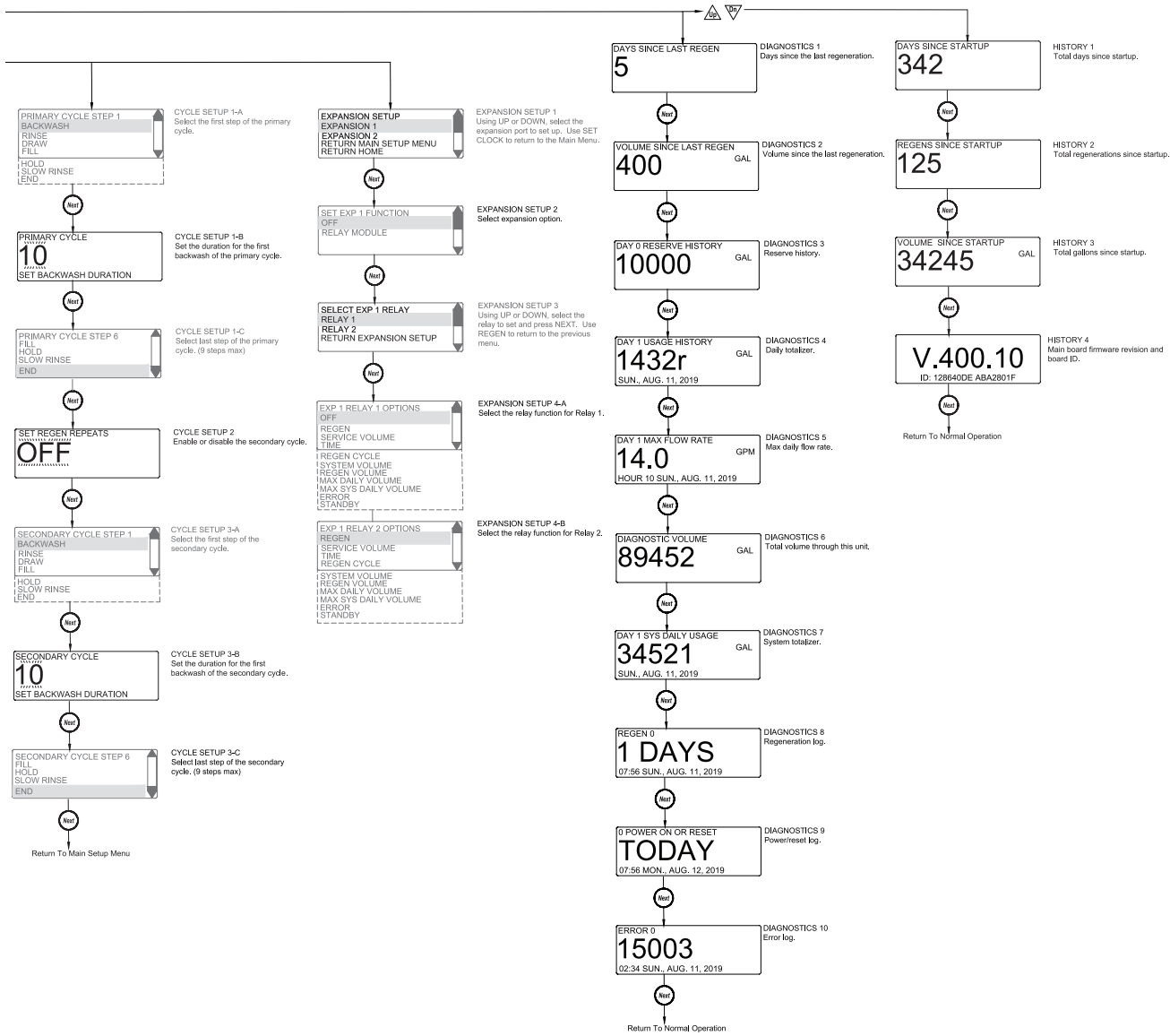

List Of Error Codes	
Code	Description
1001	No Encoder Pulses
1002	Unexpected Stall, Main Drive
1003	Run Time Too Long, Main Drive
14001	Message Queue Full
15003	Run Time Too Long, Bypass Drive
15010	Run Time Too Short, Bypass Drive Could Not Drive Offline
15011	Run Time Too Short, Bypass Drive Could Not Drive Online
16001	Communication Lost With Unit 2
16002	Communication Lost With Unit 3
16003	Communication Lost With Unit 4
18000	Reset Performed
18001	Power Loss
18002	Power Restored
20001	Run time too long, AUX drive
20002	Run time too short during unwind, AUX drive
20011	Run time too short, AUX drive
21xxx	System recovery from memory error

TYPICAL USER SCREENS

USER 1

REGEN TODAY
9980 GAL
 VOLUME REMAINING 1

Set Clock Next Regen Up Dn

USER 1 - Capacity Remaining

- Displays the unit’s current capacity remaining
- This screen does not display on units with volumetric capacity turned off
- Can be manually reduced by holding the down arrow

USER 2

DAYS **14**
 DAYS REMAINING

Set Clock Next Regen Up Dn

USER 2 - Days Remaining, Single Unit

- Displays a single unit’s days until a regeneration, based on the day override setting
- This screen does not display on units with day override turned off
- On systems, the LEAD unit displays the days remaining
- Days can be manually reduced by holding the down arrow

USER 2B

UNIT **2** DAYS **14**
 DAYS REMAINING 1

Set Clock Next Regen Up Dn

USER 2B - Days Remaining, System

- The LEAD in a system displays the days until a regeneration, based on the day override settings.
- The displays also indicates which unit the day override is currently pertaining to
 - Series regen systems do not display a unit as they will regenerate all units sequentially

USER 3

4:15 PM
 MON., AUG. 12, 2019

Set Clock Next Regen Up Dn

USER 3 - Time

- Displays the current date and time of day

USER 4

48.5 GPM
 CURRENT FLOW RATE

Set Clock Next Regen Up Dn

USER 4 - Flow Rate, Unit

- Displays that unit’s current flow rate

USER 5

11980 GAL
 VOLUME USED

Set Clock Next Regen Up Dn

USER 5 - Volume Totalizer, Unit

- Displays the total volume since install / reset
- Resettable to zero, while in this screen, by holding the “Set Clock” & “Regen” buttons

TYPICAL USER SCREENS (CONTINUED)

USER 6

48.5 GPM
4 UNITS
SYSTEM FLOW RATE 1

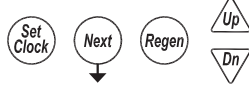

USER 6 – Flow Rate, System

- Displays the current combined flow rate of all the units in the system
- This screen does not display on single tank units or systems with volumetric capacity turned off

USER 7

221980
SYSTEM GALLONS USED 1

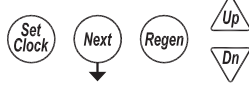

USER 7 – Volume Totalizer, System

- Displays the total volume of the system since install / reset
- Resettable to zero, while in this screen, by holding the “Set Clock” & “Regen” buttons
- This screen does not display on single tank units

TO USER 1

SETTING TIME OF DAY AND DATE

SET TIME AND DATE

Accessed by pressing Set Clock while in the User Screens. Use UP or DOWN arrows to scroll through the available settings.

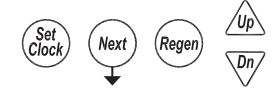
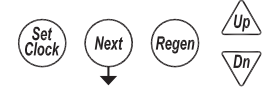
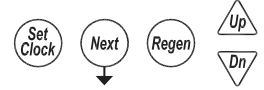
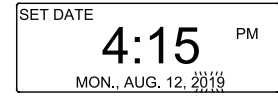
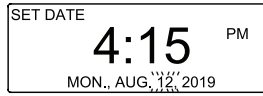
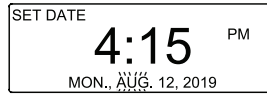
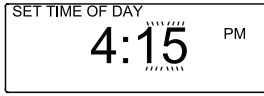
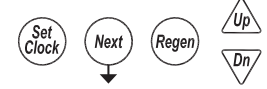
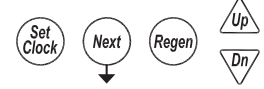
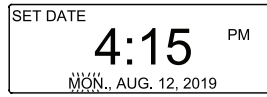
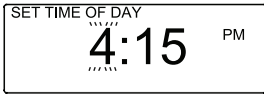

RETURN TO NORMAL OPERATION

NOTIFICATIONS



• REGEN TODAY

- Flashing indicates a regeneration has been manually set and can be turned off by pressing and releasing the REGEN button
- A solid display indicates the regeneration has been scheduled by input requirements and can't be manually turned off

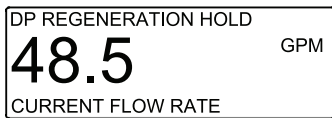

• REGENERATION HOLD / REGENERATION START

- The display will flash "DP REGENERATION HOLD" or "DP REGENERATION START", depending on settings, to indicate an external switch closure to the Aux. Input

• HIGH VOLUME

- Screen flashes indicating setpoint was reached when using relay outputs to signal high water usage. All LED lights flash and the relay with that setpoint closes.
 - Screen and the relay are reset by pressing any button
 - System operates as normal behind the indicator screen.
- Only active if Timer 2 or Timer 3 is set to "Day & Gal" or "Day & Gal & System"

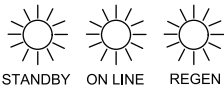

ERRORS

• NUMBER OF UNITS ERROR

- The LEAD unit of a system would flash an error screen alerting of a loss of communication with a unit
- Check for proper operation and connectivity of the unit specified as lost communications
- Pressing any button will return the user to the # units set up screen to correct / verify the value of units in the system. Exiting will re-establish communications
- Each unit of the system will regenerate, based on its settings, with hard water bypass

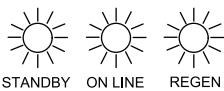

• FUNCTIONAL ERROR

- "Error" and its code will flash on the display with a red backlight
- The unit attempts to return to service but will not regenerate until the error is cleared
- See troubleshooting section for a description of possible error codes.



MAIN MENU SCREEN

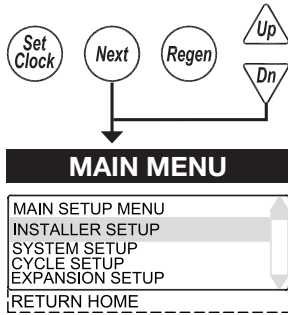

Accessed by pressing NEXT and DOWN simultaneously for >3 seconds while in one of the user screens.

INSTALLER SETUP - Setup items under the Installer Setup Screens section

SYSTEM SETUP - Setup items in the System Setup Screens section

CYCLE SETUP - Setup the primary and secondary regeneration cycles

EXPANSION SETUP - Setup expansion port options if expansion boards are installed

RETURN HOME - Return back to the user screens

- Once you are in any of the submenus, use the REGEN button to back out to the Main Menu
- The SET CLOCK button will typically exit from any menu and return to the user screens

SYSTEM SETUP SCREENS

Accessed by pressing NEXT and DOWN simultaneously for >3 seconds and selecting SYSTEM SETUP from the Main Menu. On multi-unit systems, only program the main valve number one or the LEAD unit.

- System setup screens will be locked on units determined to be a LAG of a system
 - LAG units need to be reset, "Next" & "Regen" from any screen to have their LAG status turned off.

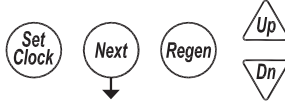
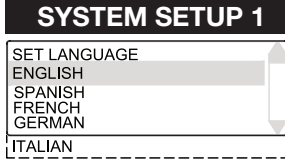

SYSTEM SETUP 1 – Select language

Select one of the available languages to be used when displaying text on the display.

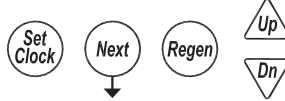
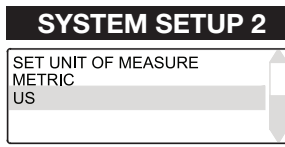

SYSTEM SETUP 2 - Set unit of measure

Select either Metric units or US units for measurements.

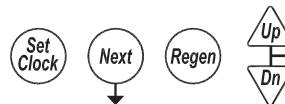
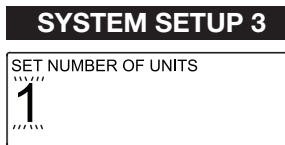

SYSTEM SETUP 3 - Set number of units

Up to 16 units can be daisy chained using the communication in and out ports on the controls.

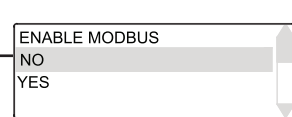

SYSTEM SETUP 3A - Enable or disable Modbus

Enable or disable the Modbus communication protocol.

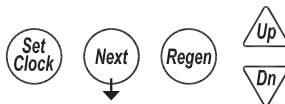
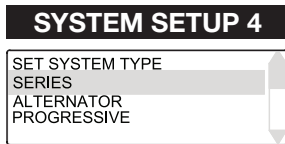

SYSTEM SETUP 4 – Select System Type / Operation

This screen is only available if the number of units selected is greater than 1.

Series: All units are always online unless they are regenerating.

- Units in a series flow system will determine the need to regenerate based on:
 - Any one unit reaching 0 capacity
 - Day override
- Any one unit's need to regenerate will initiate sequential regenerations of all units (series regeneration)
- Immediate systems will regenerate all units in series upon the first unit reaching 0 capacity
- Delayed units will regenerate during one or more of the delayed regeneration windows

Alternator: Operates the system as an alternator, having one unit off-line at all times either regenerating or fully regenerated.

- A unit in an alternator system will determine the need to regenerate based on:
 - The current LEAD unit reaching 0 capacity
 - Immediate systems immediately regenerate and alternate the exhausted unit with a fully regenerated standby unit.
 - Delayed systems will immediately alternate the exhausted unit with a fully regenerated standby unit, and regenerate at the next available time slot.
 - LEAD unit regenerates based on LAG units
 - The first LAG unit depleting down to 15% less than its ratio of system capacity
 - 1/3 for a 4 unit; 1/2 for a 3 unit
 - The second LAG unit depleting down to 15% less than its ratio of system capacity
 - 2/3 for a 4 unit

SYSTEM SETUP SCREENS (CONTINUED)

- Delayed systems will flag LEAD units based on LAG capacity, but will not alternate with remaining capacity until the next available delayed time.
- Day override
 - 1 day; 1 unit will regen
 - Day triggered regens will run at the time set for the first regeneration window
- Progressive (Demand Recall):** one unit is always online & additional units are added as the online units exceed the flow add point.
 - Additional units are brought online when:
 - The adder point is exceeded for 30 seconds
 - All required units required to cover the flow conditions will be brought into service immediately if the flow exceeds 120% of the adder point.
 - Units will go off-line when
 - System flow reduces to 95% of the set adder point / unit for 1 minute.
 - Any unit in a demand recall system will determine the need to regenerate based on:
 - Each unit individually reaching 0 capacity
 - Immediate systems will regenerate depleted units immediately after current flow conditions allow depleted units off-line.
 - Delayed units will alternate LEAD units immediately upon exhaustion and regenerate them at the next available time slot.
- Day Override
 - One unit will be regenerated per delayed time slot (i.e. a 4 unit system will need 4 delayed times to regenerate all units / set number of days).
 - Day triggered regens will run at the time set in the first regeneration window
- Units cannot regenerate if flow demands them to remain online
 - Immediate units regen immediately after flow allows them off-line
 - Delayed units regen at the next available time slot
 - Day units regen at the next time slot

SYSTEM SETUP 4A

SET FLOW ADD POINT
1
 GALLONS PER MINUTE

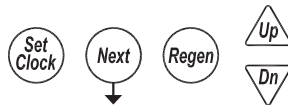

SYSTEM SETUP 4A - Set flow add point

- Only available on Progressive systems
- Sets the flow rate which controls the point at which more valves are brought online or taken off-line based on the flow rate

SYSTEM SETUP 4B

SET AUTO RINSE DURATION
1:00

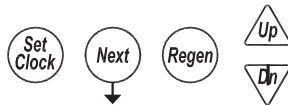

SYSTEM SETUP 4B - Set Pre-Service Rinse

- Only available on Alternator systems
- Standby units will run through a rinse cycle before coming into service

SYSTEM SETUP 5

SET ISOLATION TIMING
 HARD WATER BYPASS
 NO HARD WATER BYPASS
 SEPARATE SOURCE INLET
 SIMPLE ALT SHARING MAV
 RELAY

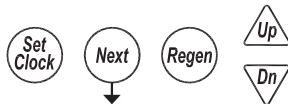

SYSTEM SETUP 5 - Select bypass control

- Selections allow enabling and timing control of motorized drive
- Selection availability can vary by the type of system
- Custom timing sequences can be configured under “Custom Motorized Drive Timing” at the end of the programming section

Hardwater Bypass

- Only available on single units
- Unit will internally bypass hard water to the service lines while in regeneration

No Hardwater Bypass

- Each unit has isolation to control system operation and will not supply service water during regeneration
- Drive timing will bring the unit into service during fill

SYSTEM SETUP SCREENS (CONTINUED)

Separate Source

- Each unit has isolation to control system operation and will not supply service water during regeneration
- Drive timing will keep units isolated through the entire regeneration sequence

Simple Alt Sharing MAV

- Only available when set to a 2 unit alternator
- A “Simple 2 Unit” shares one MAV to be electrically connected to the bypass connection of the “B” (LAG) unit

Relay

- Only available when when the optional relay expansion module is installed and one or both of the relays is set for Standby
- Isolation will be done through the optional relay expansion module and does not initialize the BYPASS motorized drive circuit

Simple Alt Sharing MAV

- Only available when set to a 2 unit alternator
- A “Simple 2 Unit” shares one MAV to be electrically connected to the bypass connection of the “B” (LAG) unit

SYSTEM SETUP 6

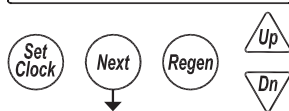

SYSTEM SETUP 6 – Set unit capacity

- Only available for US based measurements
- Allows for automatic calculation of tank capacity or user entered capacity

SYSTEM SETUP 7

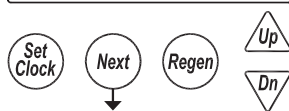

SYSTEM SETUP 7 - Set the ionic capacity of the tank

- Only available for US based measurements
- Used for auto-calculation of unit capacity

SYSTEM SETUP 8

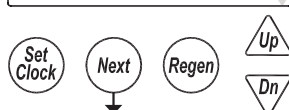

SYSTEM SETUP 8 - Day override control

- 28 day time clock: Used to regenerate units based on a set number of days between regenerations
- 7 Day Time Clock: Used to control regeneration based on specific days
- OFF: Days have no control on regenerations, and will not be a selection if volumetric capacity is set to OFF

SYSTEM SETUP SCREENS (CONTINUED)

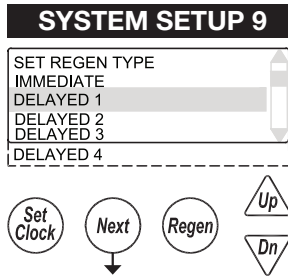

SYSTEM SETUP 9 - Regeneration control

Delayed 1 – 4

- Delays regeneration of units upon reaching 0 gallons capacity
- Allows setting of up to 4 regeneration windows per day
- Systems with delayed regen will remove a unit from service based upon 0 capacity and regenerate at the scheduled regen time.
 - Any unit needing regeneration while the window of time is available will be able to regenerate. Only one unit will regen at a time
 - Day driven regens will regen at the Delayed 1 window time
 - Depleted units will regen at the next available delayed time slot

Immediate-Immediate regeneration of units upon reaching 0 capacity

-Series regeneration systems set to Immediate will sequentially regenerate all units at the delayed time based on day override

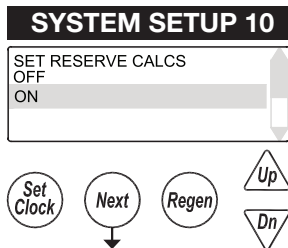

SYSTEM SETUP 10 – Automatic reserve calculation

This screen will not display on units set to Immediate, capacity set to Off, or any multi-unit systems

On: Unit will regenerate before reaching 0 capacity, based on previous usage trends

Requires delayed regeneration

OFF: Regeneration is scheduled after reaching 0 capacity

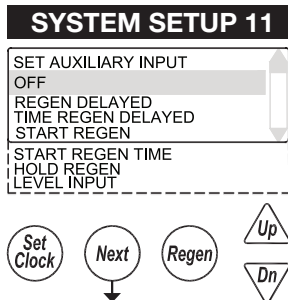

SYSTEM SETUP 11 - Auxiliary Input

OFF

- Auxiliary input is disabled

REGEN DELAYED

- Control will immediately schedule a regen upon switch closure
- Systems follow “Delayed Logic” regenerating flagged units in available time slots

TIME REGEN DELAYED

- Control will immediately schedule a regeneration upon accumulating 2 minutes of intermittent switch closures
- Systems follow “Delayed Logic” regenerating flagged units in available time slots

START REGEN

- Control will start an immediate regeneration upon switch closure
- Systems follow “Immediate logic” regenerating all flagged units sequentially

START REGEN TIME

- Control will immediately regenerate upon accumulating 2 minutes of intermittent switch
- Systems follow “Immediate logic” regenerating all flagged units sequentially

HOLD REGEN

- Regeneration will not be allowed as long as there is switch closure
 - On0 units will regenerate immediately after the hold switch opens
 - Delayed regenerations will be delayed until the next scheduled time if the hold is active when the scheduled time passes

LEVEL INPUT

- Only available on single units
- External switching can be used to control the Online/Standby status
 - Switch closure will trigger the unit to go to a standby condition

SYSTEM SETUP SCREENS (CONTINUED)**SYSTEM SETUP 11A**

SET METER PULSES
8.0
PULSES PER GALLON

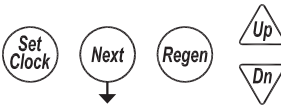
**SYSTEM SETUP 11A - Level Input option selected**

Set a time duration of switch closure when Level option is selected

SYSTEM SETUP 12

SET METER SIZE
2" METER
3" METER
VARIABLE METER
VARIABLE SYSTEM METER
3" SYSTEM METER

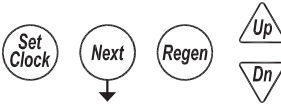
**SYSTEM SETUP 12 - Meter Size Selection**

2" METER: Setting for using a factory 2" meter

3" METER: Setting for using a factory 3" meter

VARIABLE METER: Used to set meter input off custom pulse rate, typically for non-factory meters

VARIABLE SYSTEM METER: Only available on 2 unit alternators. The system shares 1 external meter which is connected to the LAG unit's meter connection.

3" SYSTEM METER: Only available on 2 unit alternators. The system shares 1 external meter which is connected to the LAG unit's meter connection.

SYSTEM SETUP 12A

SET METER PULSES
8.0
PULSES PER GALLON

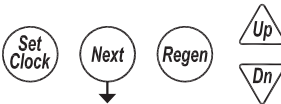
**SYSTEM SETUP 12A - Set Meter Pulses / Gallon**

-Only displays if "VARIABLE METER" or "VARIABLE SYSTEM METER" is selected in the previous screen

-Set to the desired pulse rate of the installed metering device

SYSTEM SETUP 13

SET AUX DRIVE TYPE
OFF
NO HARD WATER BYPASS
SEPARATE SOURCE INLET

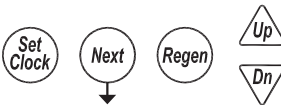
**SYSTEM SETUP 13- Auxiliary Drive**

- Selections allow enabling and timing control of the Auxilliary motorized drive circuit
- Requires a factory motorized drive to be connected to the AUX DRIVE connector
- Custom timing sequences can be configured under "Custom Motorized Drive Timing" at the end of the programming section

Off

- The auxiliary drive output is disabled

No Hard Water Bypass

- Each unit has isolation to control system operation and will not supply service water during regeneration
- Drive timing will bring the unit into service during fill

Separate Source

- Each unit has isolation to control system operation and will not supply service water during regeneration
- Drive timing will keep units isolated through the entire regeneration sequence

CYCLE SETUP SCREENS

Accessed by pressing NEXT and DOWN simultaneously for >3 seconds and selecting CYCLE SETUP from the Main Menu.

CYCLE SETUP 1A

SET CYCLE 1 STEP 1

BACKWASH

RINSE

DRAW

FILL

HOLD

SLOW RINSE

END

CYCLE SETUP 1A

Select first step of the primary regeneration cycle.

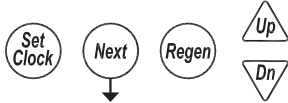

CYCLE SETUP 1B

PRIMARY CYCLE

10

SET BACKWASH DURATION

CYCLE SETUP 1B

Select the time of duration for the first step of the primary regeneration cycle.

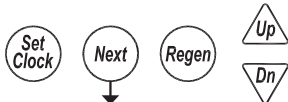

CYCLE SETUP 1C

PRIMARY CYCLE STEP 6

FILL

HOLD

SLOW RINSE

END

CYCLE SETUP 1C

Select the second step of the primary regeneration cycle.

Continue selecting the step type and entering the duration until the primary regeneration cycle has been defined.

Select END as the last step of the primary regeneration cycle.

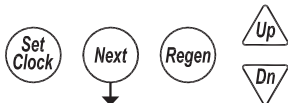

CYCLE SETUP 2

SET REGEN REPEATS

OFF

CYCLE SETUP 2

Select regeneration repeats, 1-9 or OFF.

Repeats the primary regeneration cycle a selected number of times before regenerating a single time with the secondary regeneration cycle.

The following screens will not appear if regeneration repeats is set to OFF.

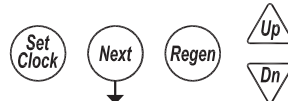

CYCLE SETUP 3A

SET CYCLE 2 STEP 1

BACKWASH

RINSE

DRAW

FILL

HOLD

SLOW RINSE

END

CYCLE SETUP 3A

Select first step of the secondary regeneration cycle.

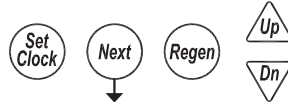

CYCLE SETUP 3B

SET CYCLE 2 DURATION

10

SET BACKWASH DURATION

CYCLE SETUP 3B

Select the time of duration for the first step of the secondary regeneration cycle.

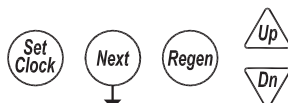

CYCLE SETUP SCREENS (CONTINUED)

CYCLE SETUP 3C

SECONDARY CYCLE STEP 6
FILL
HOLD
SLOW RINSE
END

Set Clock Next Regen

Up
Dn

RETURN TO MAIN MENU

CYCLE SETUP 3C

Select the second step of the secondary regeneration cycle.
Continue selecting the step type and entering the duration until the secondary regeneration cycle has been defined.
Select END as the last step of the secondary regeneration cycle.

EXPANSION SETUP SCREENS

Accessed by pressing NEXT and DOWN simultaneously for >3 seconds and selecting EXPANSION SETUP from the Main Menu.

EXPANSION SETUP 1

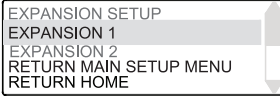

EXPANSION SETUP 1

Select the expansion port, 1 or 2, that you will modify.

EXPANSION SETUP 2

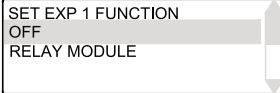

EXPANSION SETUP 2

Select the installed expansion board or OFF if no expansion board is installed.

EXPANSION SETUP 2A

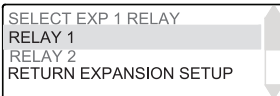

EXPANSION SETUP 2A

If RELAY MODULE was selected from Expansion Setup 2, select which relay to modify.

EXPANSION SETUP 2B

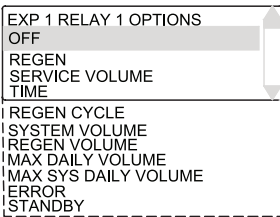

EXPANSION SETUP 2B

Select how the relay should function or OFF if the relay will not be used.

OFF - Relay is not used

REGEN - The relay is energized while the control is regenerating

SERVICE VOLUME - The relay is energized, during service only, every specified amount of volume used and for a specified amount of time

TIME - The relay is energized based on a set amount of time after the start of regeneration and will stay energized for a specified amount of time

REGEN CYCLE - The relay is energized based on the start of a specified cycle and will stay energized for a specified amount of time

SYSTEM VOLUME - The relay is energized, at a specified volume, based on combined volume usage of all units in the system and stays energized for a specified time. Only available on the LEAD unit of a system.

REGEN VOLUME - The relay is energized, during service & while in regen, every specified amount of service flow and for a specified amount of time

MAX DAILY VOLUME - The relay is energized, based on a units usage, at a specified daily volume to signal a usage alarm. "HIGH VOLUME ERROR" flashes on the screen while unit continues to operate as normal. Pressing any button resets the relay and returns the unit to the user screens.

MAX SYS DAILY VOLUME - The relay is energized, at a specified amount, based on combined volume usage of all units in the system. "HIGH VOLUME ERROR" flashes on the screen while unit continues to operate as normal. Pressing any button resets the relay and returns the unit to the user screens. Only available on the LEAD unit of a system

ERROR - The relay is energized to signal an error condition

STANDBY - The relay is energized based on the unit's Standby status. Relays could be used to control external valving or signaling a unit's Online status.

EXPANSION SETUP SCREENS (CONTINUED)

EXPANSION SETUP 2B-1A

SET EXP 1 RLY 1 VOLUME
 20 GAL
 SERVICE VOLUME

EXPANSION SETUP 2B-1A SERVICE VOLUME

- Enter the volume at which the relay should energize

EXPANSION SETUP 2B-1B

SET EXP 1 RLY 1 ON TIME
 3:00
 RELAY ON TIME

EXPANSION SETUP 2B-1B SERVICE VOLUME

- Enter the total time to keep the relay energized

EXPANSION SETUP 2B-2A

SET EXP 1 RLY 1 DLY TIME
 10:00
 RELAY START DELAY

EXPANSION SETUP 2B-2A TIME

- Enter the delay time, after regeneration starts, before energizing the relay

EXPANSION SETUP 2B-2B

SET EXP 1 RLY 1 ON TIME
 3:00
 RELAY ON TIME

EXPANSION SETUP 2B-2B TIME

- Enter the total time to keep the relay energized

EXPANSION SETUP 2B-3A

SET RELAY 1 CYCLE
 BACKWASH
 RINSE
 DRAW
 FILL
 HOLD
 SLOW RINSE

EXPANSION SETUP 2B-3A REGEN CYCLE

- Select the regeneration cycle to energize the relay

EXPANSION SETUP 2B-3B

SET EXP 1 RLY 1 ON TIME
 3:00
 RELAY ON TIME

EXPANSION SETUP 2B-3B REGEN CYCLE

- Enter the total time to keep the relay energized

EXPANSION SETUP 2B-4A

SET EXP 1 RLY 1 VOLUME
 20 GAL
 SYSTEM VOLUME

EXPANSION SETUP 2B-4A SYSTEM VOLUME

- Enter the volume at which the relay should energize

EXPANSION SETUP 2B-4B

SET EXP 1 RLY 1 ON TIME
 3:00
 RELAY ON TIME

EXPANSION SETUP 2B-4B SYSTEM VOLUME

- Enter the total time to keep the relay energized

EXPANSION SETUP SCREENS (CONTINUED)

EXPANSION SETUP 2B-5A

SET EXP 1 RLY 1 VOLUME
20 GAL
REGEN VOLUME

EXPANSION SETUP 2B-5A REGEN VOLUME

- Enter the volume at which the relay should energize

EXPANSION SETUP 2B-5B

SET EXP 1 RLY 1 ON TIME
3:00
RELAY ON TIME

EXPANSION SETUP 2B-5B REGEN VOLUME

- Enter the total time to keep the relay energized

EXPANSION SETUP 2B-6A

SET EXP 1 RLY 1 VOLUME
20 GAL
MAX DAILY VOLUME

EXPANSION SETUP 2B-6A MAX DAILY VOLUME

- Enter the volume at which the relay should energize

EXPANSION SETUP 2B-7A

SET EXP 1 RLY 1 VOLUME
20 GAL
MAX SYS DAILY VOLUME

EXPANSION SETUP 2B-7A MAX SYS DAILY VOLUME

- Enter the volume at which the relay should energize

INSTALLER SETUP SCREENS

Accessed by pressing NEXT and DOWN simultaneously for >3 seconds and selecting INSTALLER SETUP from the Main Menu.

INSTALLER 1

SET HARDNESS
20
GRAINS

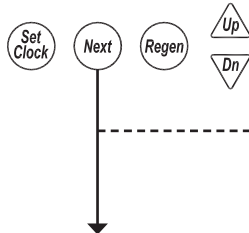

INSTALLER 1 – Set hardness

Set the inlet water hardness, in grains.

- This screen is only available if set to US units of measurement.
- This screen is not available if System Setup 6 is set to OFF.

Set current day and regen days when set as a 7 day time clock in System Setup 8. See next page.

INSTALLER 2

SET DAYS OVERRIDE
14
DAYS

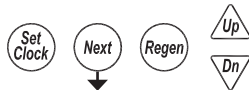

INSTALLER 2 – Set Days Between Regenerations (Day override)

Set day override. 1-28 days between regenerations, or if set to 7 day time clock, see 7 day setup on next page. OFF will only be displayed if “OFF” is selected in System Setup 8.

- Settings will be based on the type of day override control set in system setup.
- Off will be displayed for units with day override turned off

1 – 28: When set as a 28 day override

- Set the days between regens

1 – 7: When set as a 7 day timeclock

- Turn regen on or off for each specific day of the week, Sunday - Saturday

INSTALLER 3

SET REGEN TIME 1 HOUR
2:00
AM
OPEN TIME HOUR

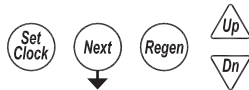

INSTALLER 3 – Set Delayed Regeneration Open Time Hour

• A maximum of 4 regeneration windows can be set up. Set up the open time (hour:minute) and close time (hour:minute) for each window.

- Set the delayed time of regeneration, hour (AM / PM toggles at midnight)

INSTALLER 4

SET REGEN TIME 1 MINUTE
2:00
AM
OPEN TIME MINUTES

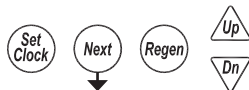

INSTALLER 4 – Set Delayed Regeneration Open Time Minute

- Set delayed time of regeneration, minute

INSTALLER 5

SET REGEN TIME 1 HOUR
3:00
AM
CLOSE TIME HOUR

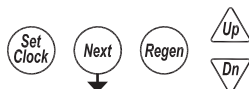

INSTALLER 5 – Set Delayed Regeneration Close Time Hour

- Set the delayed time of regeneration, hour (AM / PM toggles at midnight)

INSTALLER SETUP SCREENS (CONTINUED)

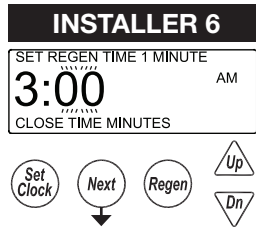

INSTALLER 6 – Set Delayed Regeneration Close Time Minute

- Set delayed time of regeneration, minute
- When configured for multiple delayed regeneration windows, repeat Installer steps 3 through 6 for each additional window

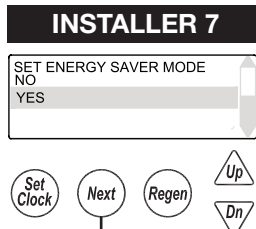

INSTALLER 7 – Set Energy Saver Mode

- When enabled, the backlight will turn off after five minutes of no flow and no button presses

RETURN TO NORMAL OPERATION

7 DAY OPTION

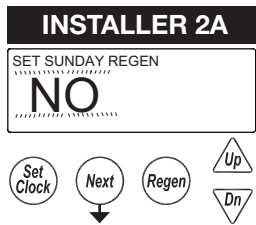

INSTALLER 2A

- Use UP or DOWN to toggle between YES or NO to control regeneration for each day
- Press NEXT to advance to the next day
- Repeat for each day of the week (e.g., no regeneration on Sunday)

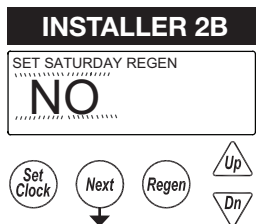

INSTALLER 2B

- Use UP or DOWN to toggle between YES or NO (e.g., regeneration on Saturday)

INSTALLER 3
(see previous page)

DIAGNOSTIC SCREENS

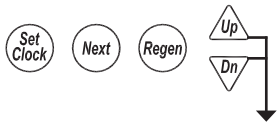

Accessed by pressing **UP** and **DOWN** simultaneously for >3 seconds.

DIAGNOSTIC 1



DIAGNOSTIC 1

Days since the last regeneration.

All Diagnostic History screens are resettable with the History Reset sequence while in the Diagnostics 1 screen. Holding the Set Clock and Regen buttons for > 3 seconds initiates a totalizer or history reset.

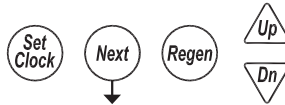

DIAGNOSTIC 2



DIAGNOSTIC 2

Volume since the last regeneration.

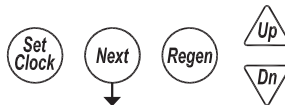

DIAGNOSTIC 3



DIAGNOSTIC 3

- Displays the reserve history
- Does not display on systems or units with reserve set to OFF
- Use the UP & DN arrows to scroll through each day's history
 - Day 0 is today's reserve (tomorrows anticipated usage)
 - 1 was yesterday's reserve (today's anticipated usage)

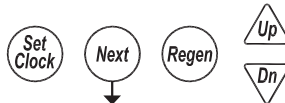

DIAGNOSTIC 4



DIAGNOSTIC 4

History of volume used.

Use UP and DOWN arrows to select a day.

0 = Today

1 = Yesterday

127 = 127 days ago (max.)

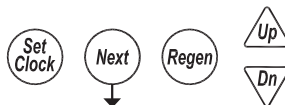

Simultaneously press UP and DOWN.

An "r" will be displayed after the volume amount if a regeneration occurred that day.

GO TO DIAGNOSTIC 5

GO TO DIAGNOSTIC 4A

DIAGNOSTIC SCREENS (CONTINUED)

DIAGNOSTIC 4A

DIAGNOSTIC 4A

Hourly history of volume use. Use the UP and DOWN arrow to select the hours of the day.

DAY 1 HOURLY USAGE
140r GAL
 HOUR 00 SUN., AUG. 11, 2019

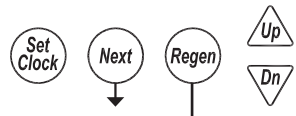

→ Returns user back to USE Day 0 in Diagnostic 4 screen.

DIAGNOSTIC 5

DIAGNOSTICS 5

- Displays the max flow rate and the hour it occurred
- Use the UP & DN arrows to scroll through 128 days history
- Day 0 is today
- Day 1 was yesterday

DAY 1 MAX FLOW RATE
14.0 GPM
 HOUR 10 SUN., AUG. 11, 2019

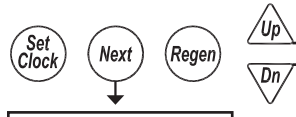

**GO TO
DIAGNOSTIC 6**

Simultaneously
press UP and
DOWN.

DIAGNOSTIC 5A

DIAGNOSTICS 5A

Hourly history of maximum flow rate. Use the UP and DOWN arrows to select the hours of the day from screen 5.

DAY 1 HOURLY FLOW RATE
9.0 GPM
 HOUR 08 SUN., AUG. 11, 2019

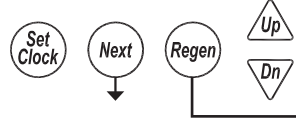

→ Returns user back to USE Day 0 in Diagnostic 5 screen.

DIAGNOSTIC 6

DIAGNOSTIC 6

Total volume through the unit.

DIAGNOSTIC VOLUME
89452 GAL

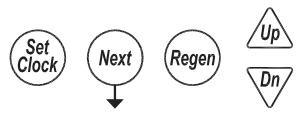

DIAGNOSTIC 7

DIAGNOSTICS 7

Total system history of volume used. Use UP and DOWN arrows to select a day.
 0 = Today
 1 = Yesterday
 127 = 127 days ago (max.)

DAY 1 SYS DAILY USAGE
34521 GAL
 SUN., AUG. 11, 2019

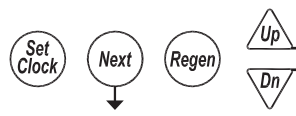

**GO TO
DIAGNOSTIC 8**

Simultaneously
press UP and
DOWN.

**GO TO
DIAGNOSTIC 7A**

DIAGNOSTIC SCREENS (CONTINUED)



DIAGNOSTICS 7A

Total system hourly history of volume. Use UP and DOWN arrows to select the hours of the day from Screen 7.

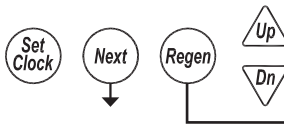

→ Returns user back to USE Day 0 in Diagnostic 7 screen.

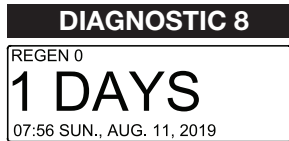

DIAGNOSTICS 8

- Displays the time and day of the last 40 regenerations
- Use the UP and DOWN arrows to scroll through each saved regeneration

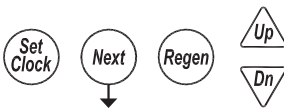

DIAGNOSTICS 9

- Displays the time and day of the last 20 power-up/resets
- Use the UP and DOWN arrows to scroll through each saved power-up/reset

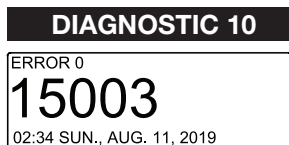
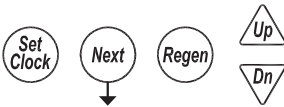

DIAGNOSTICS 10

- Displays the time and day of the last 20 errors
- Use the UP and DOWN arrows to scroll through each saved error

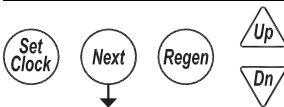

RETURN TO USER SCREEN

VALVE HISTORY

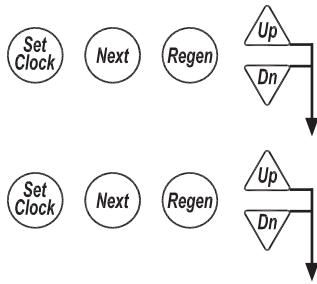

Accessed by pressing UP and DOWN simultaneously for >3 seconds, then by pressing UP and DOWN simultaneously again for >3 seconds. Non-Resettable

HISTORY 1



HISTORY 1

Total days since startup. Time only accumulates while the unit is plugged in.

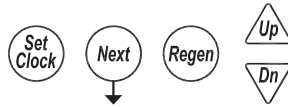

HISTORY 2

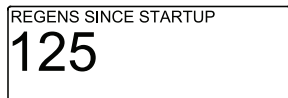

HISTORY 2

Total regenerations since startup.

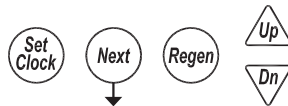

HISTORY 3



HISTORY 3

Total volume treated since startup.

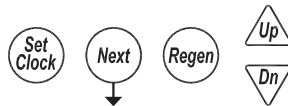

HISTORY 4



HISTORY 4

Main board software

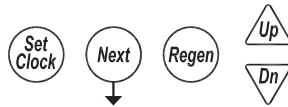

RETURN TO NORMAL OPERATION

CUSTOM MOTORIZED DRIVE TIMING

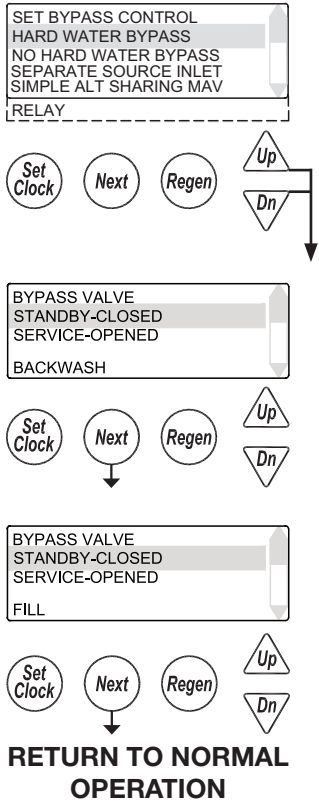

- Used to alter the standard timing sequence of the motorized isolation valve for complete custom timing of the drive circuits
 - Setup procedure applies to both the “Bypass” drive and “Aux” drive
- Customization needs to be done after defining the regeneration cycle sequence
- Accessed by pressing the UP and DOWN arrows simultaneously while in the No Hard Water Bypass selection
 - Next will scroll through each cycle of the regeneration program
 - Arrow buttons toggle Standby and Online indicating the desired position of the drive during that cycle of the regeneration.
 - In the example screens, the “Bypass” drive will be transitioning off-line for Backwash (Cycle 1) and coming online for Fill (Cycle 5).

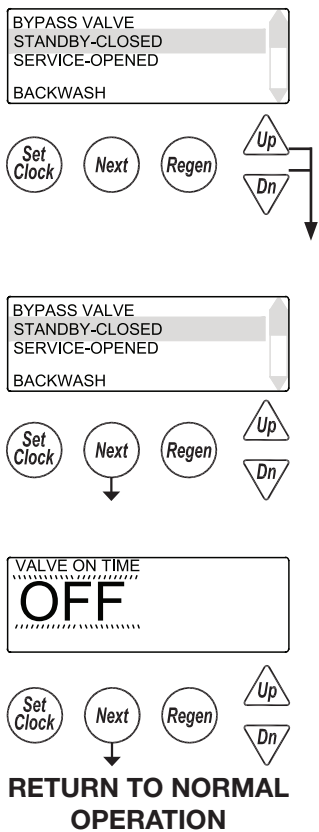

- Timing can be further customized per cycle by adding a time delay to the sequence
 - Accessed by pressing the UP and DOWN arrows simultaneously while in the drive sequence screens
 - Setting a “Start Time” delays the start of that transition after reaching set cycle
 - A second time screen then sets the time the drive maintains that set position before transitioning back to its previous position.
 - “Regen” will be illuminated to identify that a sequence has a time modifier associated with it
 - In the example screens, the “Bypass” drive will delay its transition to off-line until 2 minutes into Backwash (Cycle 1) and coming online for Fill (Cycle 5).

MODBUS INFORMATION

The WS2H, WS2HF, and WS3 can use Modbus through a half-duplex RS485 connection using the COMM IN connector on the first control in a system. The baud rate is adjustable from 9600 to 115200 (default).

To enable Modbus, select System Setup 3 (Set Number of Units) and hold the UP and DOWN arrows for >3 seconds. Once the screen appears for enabling Modbus, select “Yes” from the menu and press NEXT. Select the desired baud rate and press NEXT. Set the address of the device (0 – 247) and press NEXT.

Standard T568B Cable

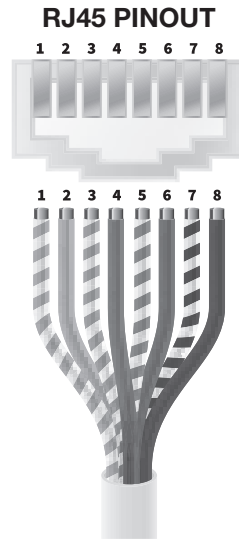

1	White/Orange
2	Orange
3	White/Green
4	Blue
5	White/Blue
6	Green
7	White/Brown
8	Brown

For wiring to a RS485 connection on a PLC

- RJ45 connector is plugged into the Incoming (Modbus) port of Unit 1
- WHT/ORG and WHT/GRN both connect to PLC DATA+
- ORG and GRN both connect to PLC DATA-
- BRN and WHT/BLU to PLC GND if needed

Wiring for USB to RS485 Adapter ULinx 485USBTB-4W

Pin	Function	T-568B Cable Colors
1	TDA(-)	GRN
2	TDB(+)	WHT/GRN
3	RDA(-)	ORG
4	RDB(+)	WHT/ORG
5	GND	BRN and WHT/BLU

MODBUS INFORMATION (CONTINUED)

Modbus Register	Description	Valid Values	Properties
40001	Year	0-99	R/W
40002	Month	1-12	R/W
40003	Day	1-31	R/W
40004	Day of Week	0-6	R/W
40005	Hour (24 Hour Format)	0-23	R/W
40006	Minute	0-59	R/W
40007	Seconds	0-59	R/W
40008	Days left until next regeneration		R
40009	System flow rate x 10 (GPM or LPM)		R
40010	System Total High Word (GAL or L)		R
40011	System Total Low Word (GAL or L)		R
40012	Regen Unit	1-16	R/W
40013	Valve 1 Flow Rate		R
40014	Valve 1 Capacity Remaining High Word (GAL or L)		R
40015	Valve 1 Capacity Remaining Low Word (GAL or L)		R
40016	Valve 1 Total Usage High Word (GAL or L)		R
40017	Valve 1 Total Usage Low Word (GAL or L)		R
40018	Valve 1 Flags High Word (GAL or L)		R
40019	Valve 1 Flags Low Word (GAL or L)		R
40020	Valve 1 Error Value		R
	Registers for Valves 2 through 15 contain the same information as Valve 1 and repeat. For example, register 40021 is Valve 2 Flow Rate, register 40029 is Valve 3 Flow Rate and so on.		
40133	Valve 16 Flow Rate		R
40134	Valve 16 Capacity Remaining High Word (GAL or L)		R
40135	Valve 16 Capacity Remaining Low Word (GAL or L)		R
40136	Valve 16 Total Usage High Word (GAL or L)		R
40137	Valve 16 Total Usage Low Word (GAL or L)		R
40138	Valve 16 Flags High Word (GAL or L)		R
40139	Valve 16 Flags Low Word (GAL or L)		R
40140	Valve 16 Error Value		R
40141	Next Regen Unit (upper byte) and Days Remaining (lower byte)		R
40142	Valve 1 Status	0-Not Connected	R
40143	Valve 2 Status	1-Service	R
40144	Valve 3 Status	2-Service Fill	R
40145	Valve 4 Status	3-Regen Fill	R
40146	Valve 5 Status	4-Regen	R
40147	Valve 6 Status	5-Regen Rinse	R
40148	Valve 7 Status	6-Error	R
40149	Valve 8 Status	7-Standby	R
40150	Valve 9 Status		R
40151	Valve 10 Status		R
40152	Valve 11 Status		R
40153	Valve 12 Status		R
40154	Valve 13 Status		R
40155	Valve 14 Status		R
40156	Valve 15 Status		R
40157	Valve 16 Status		R

MODBUS INFORMATION (CONTINUED)

Next Regen Unit (upper byte) and Days Remaining (lower byte)

A decimal value of 270 in hexadecimal is 0x010E. Broken down, 0x01 is valve 1 and 0x0E is 14 days. For valve 6, 14 days (0x060E) a decimal value of 1550 will be read.

Combining High and Low Words into a Single Value

Modbus registers can only hold 2 bytes worth of data, but some of the values stored in the WS2H/3 control are 4 bytes long. To get those values into Modbus registers they need to be broken down into two 2-byte values.

Start with a value of 1,234,567. In hexadecimal this is represented as 0x0012D687 (4 bytes – 00 12 D6 87). That 4-byte value is broken into 0x0012 (high word) and 0xD687 (low word). Most Modbus apps that are used can take each of those values and combine them back into the 4-byte value that is started out at.

INSTALLATION

WS2H

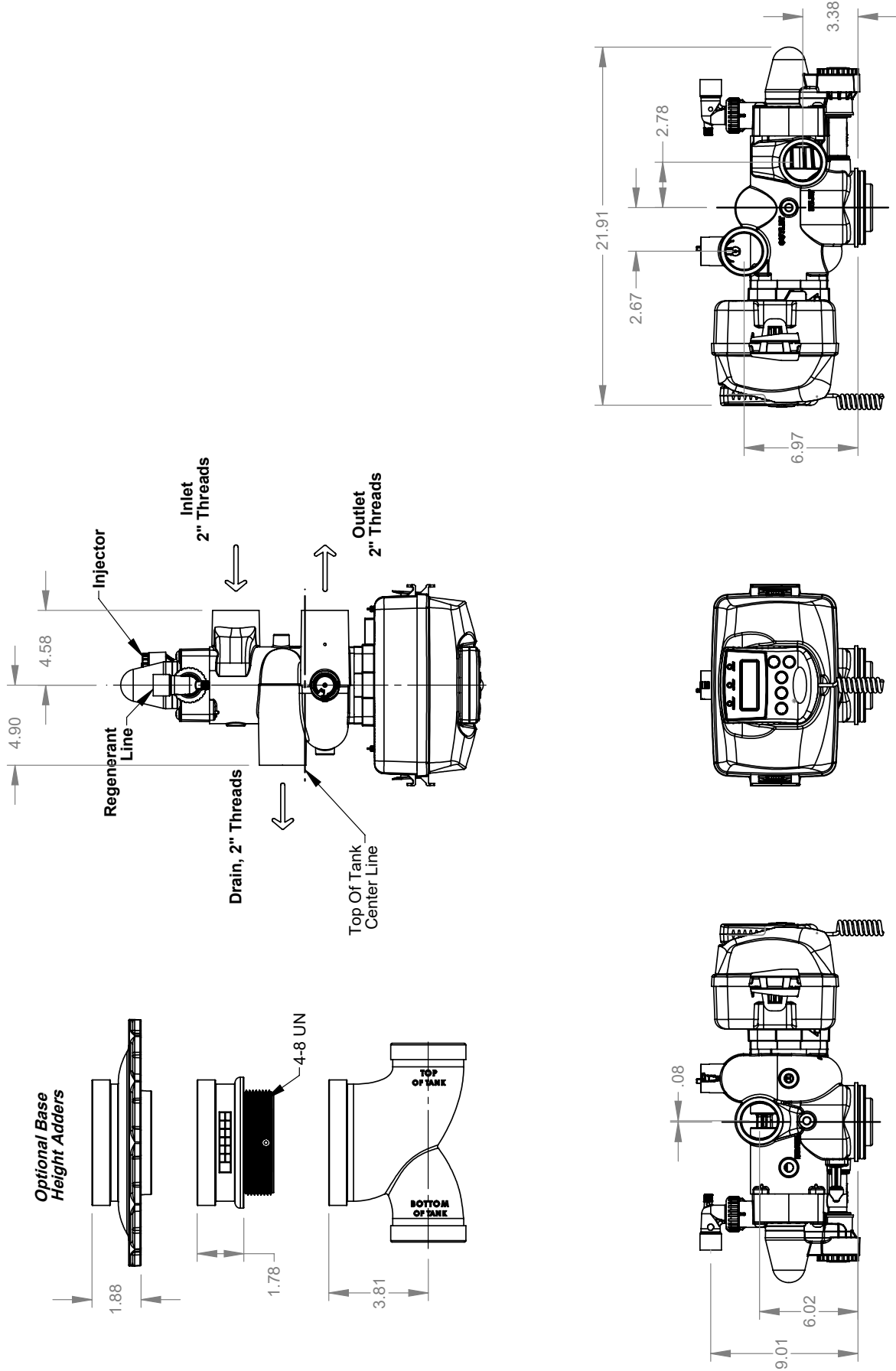

INSTALLATION (CONTINUED)

WS2HF

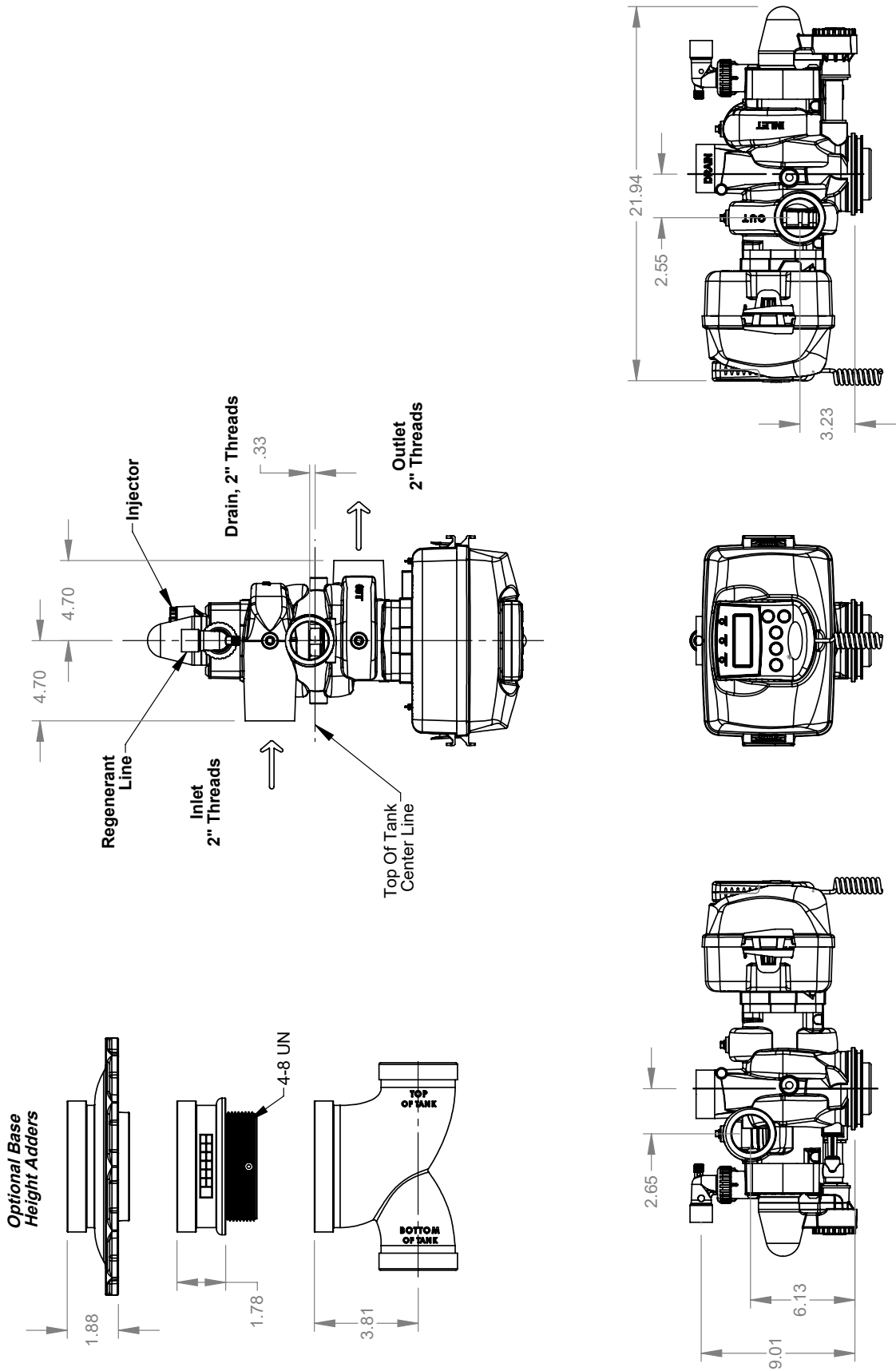

INSTALLATION (CONTINUED)

WS3

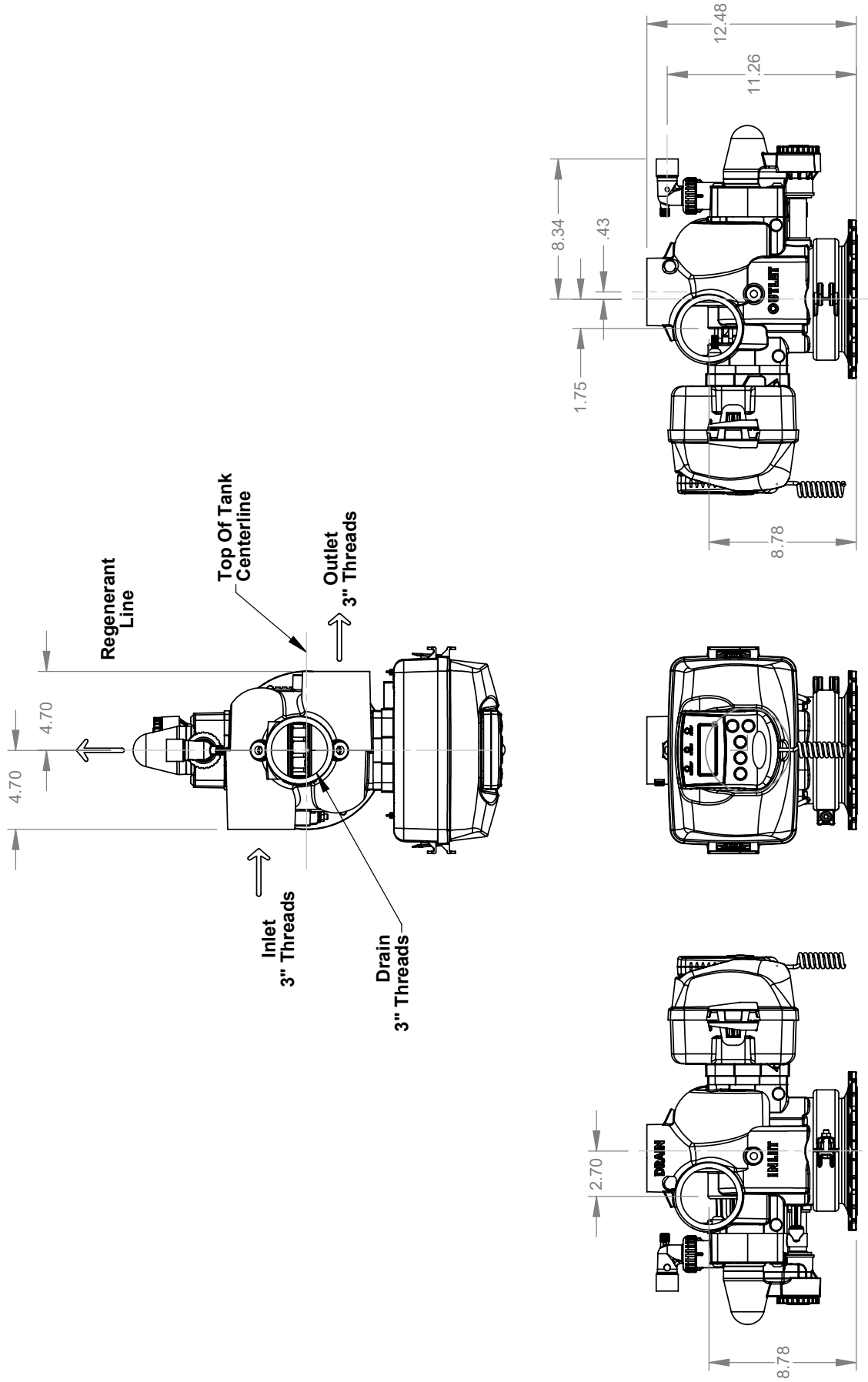

INSTALLATION (CONTINUED)

GENERAL INSTALLATION & SERVICE WARNINGS

The control valve and fittings are not designed to support the weight of the system or the plumbing.

Do not use Vaseline, oils, other hydrocarbon lubricants or spray silicone anywhere. A silicone lubricant may be used on black O-rings but is not necessary.

HYDROCARBONS SUCH AS KEROSENE, BENZENE, GASOLINE, ETC., MAY DAMAGE PRODUCTS THAT CONTAIN O-RINGS OR PLASTIC COMPONENTS. EXPOSURE TO SUCH HYDROCARBONS MAY CAUSE THE PRODUCTS TO LEAK. DO NOT USE THE PRODUCT(S) CONTAINED IN THIS DOCUMENT ON WATER SUPPLIES THAT CONTAIN HYDROCARBONS SUCH AS KEROSENE, BENZENE, GASOLINE, ETC.

THIS WATER METER SHOULD NOT BE USED AS THE PRIMARY MONITORING DEVICE FOR CRITICAL OR HEALTH EFFECT APPLICATIONS

Do not use pipe dope or other sealants on threads. Thread sealant tape is recommended to be used on all threads.

Use of pipe dope may break down the plastics in the control valve.



When servicing the valve, water may leak from the valve. Water from the valve may create a slip hazard. Clean up water spills.



Disconnect from electrical power prior to servicing the valve.

Allow two feet of clearance to service WS2H, WS2HF, and WS3 valves.

The valve will withstand transportation and storage temperatures of -13 °F (-25 °C) to 131 °F (55 °C) and for short periods up to 158 °F (70 °C). If valve has been exposed to freezing conditions, let valve warm up to room temperature before running water through it. The valve has been packaged to prevent damage from the effects of normal humidity, vibration and shock.

SITE REQUIREMENTS:

- The plug-in Power adapter is for dry locations only
- The tanks should be on a firm, level surface
- Electrical: Use an uninterrupted outlet installed within 15 feet (4.57 meters) of the water conditioner.

All plumbing should be done in accordance with local codes.

1. Locate the water conditioner so the distance between the drain and the water conditioner is as short as possible.
2. Regenerant tanks that must be refilled should be located where they are easily accessible. It is recommended a safety brine valve be used.
3. Do not install any water conditioner with less than 10 feet of piping between its outlet and the inlet of a water heater.
4. Do not locate unit where it or its connections (including the drain and overflow lines) will ever be subjected to room temperatures under 40° F (4° C).
5. The use of resin cleaners in a non-vented enclosure is not recommended.

INSTALLATION (CONTINUED)

6. Inlet/Outlet Plumbing: Connect to a supply line downstream of outdoor spigots. Install inlet and outlet shutoff valves for the control valve; see top view drawings for control valve inlet and outlet locations. Installation of a three valve bypass is recommended. If using plastic fittings, ground the water conditioner per local electric codes. If an external water meter is used, install the water meter on the outlet side of the control valve. It is recommended that the meter assembly be installed horizontally or in a downflow vertical position to reduce turbine bearing wear. The turbine assembly may be oriented in any direction. Remove the cover and drive bracket and thread the water meter cord through the hole in the backplate. Reinstall the drive bracket. Weave the cord through the strain relief on the backplate and connect the end to the three prong connector labeled FLOW on the printed circuit board. Re-install the cover.

7. Drain: Verify that the drain can handle the backwash rate of the water conditioner. Correctly size the drain line and install an appropriately sized drain line flow control. For WS2H, WS2HF, and WS3 valves, a drain line flow control is NOT supplied with a valve. For WS2H and WS2HF valves, the drain outlet is 2" Female NPT or BSPT thread connection. For WS3 valves, the drain port is 3" Female NPT or BSPT connection. If using copper, solder joints near the drain must be done prior to connecting the drain line flow control fitting. Leave at least 6" (152.4 mm) between the drain line flow control fitting and solder joints to prevent heat from damaging the flow control. Avoid elevating the drain line above the control valve where possible. Discharge the drain line through an air gap to a receptacle in accordance with local plumbing codes.

IMPORTANT: Never insert a drain line directly into a drain, sewer line, or trap. Always allow an air gap between the drain line and the receptacle to prevent back siphonage.

8. Regeneration: If the control valve is to be used to regenerate the water conditioner with brine (saturated salt solution) or other regenerants. The WS2H, WS2HF, and WS3 control valves regenerant port has a 1" 90° Male NPT threaded outlet connection that swivels 360°. To ensure acceptable operation of the injectors, use 1" pipe to connect to the brine tank. Smaller drain line flow controls may result in the injector performance not matching the injector graphs. Use an adequately sized drain line flow control to ensure proper brine draw. See Table 3 for injector order number and size for tank diameter. An overflow drain line from the regenerant tank that discharges into an acceptable drain is recommended, as a regenerant overflow could damage furnishings or the building structure. Connect a line to the overflow fitting on the regenerant tank. If an overflow fitting is not already installed on the regenerant tank, install one. Do not elevate the overflow drain line. Discharge the overflow drain line through an air gap to a receptacle in accordance with local plumbing codes.

9. Power Adapter: If a Power Adapter is already connected to the control valve, plug the Power Adapter into an uninterrupted outlet. If the Power Adapter cord has not yet been connected to the control valve, remove the control valve cover and the drive bracket and thread Power Adapter cord through the hole in the backplate. Re-install the drive bracket. Weave the cord through the strain relief on the backplate and connect the end to the four pin connector on the printed circuit board labeled POWER. Reinstall the cover. Plug the Power Adapter into an uninterrupted outlet.

10. Program the control valve: It is very important to program the control valve for the type of system (e.g. water softener or filter) and the end use application. Check the program used prior to testing the system.

INSTALLATION SUMMARY

Installation Date: _____
Installation Location: _____
Installer(s): _____
Phone Number: _____
Application Type: (Softener) _____ Other: _____

Water Source: _____

Water Test Results:

Hardness: _____ Iron: _____ pH: _____
Other: _____

Misc:

Service Flow Rates: min. _____ max. _____
Tank Size: Diameter _____ Height: _____
Resin or Media Volume: _____
Resin or Media Type: _____
Capacity: _____
Salt or Fill Setting per Regeneration: _____
Brine Tank Size: _____

Control Valve Configuration:

Valve Type: _____
Valve Part Number: _____
Valve Serial Number: _____
Regenerant Refill Control: _____ gpm/lpm
Injector Size: _____
Drain Line Flow Control: _____ gpm/lpm

CYCLE POSITIONS / FLOW DIAGRAMS

SERVICE

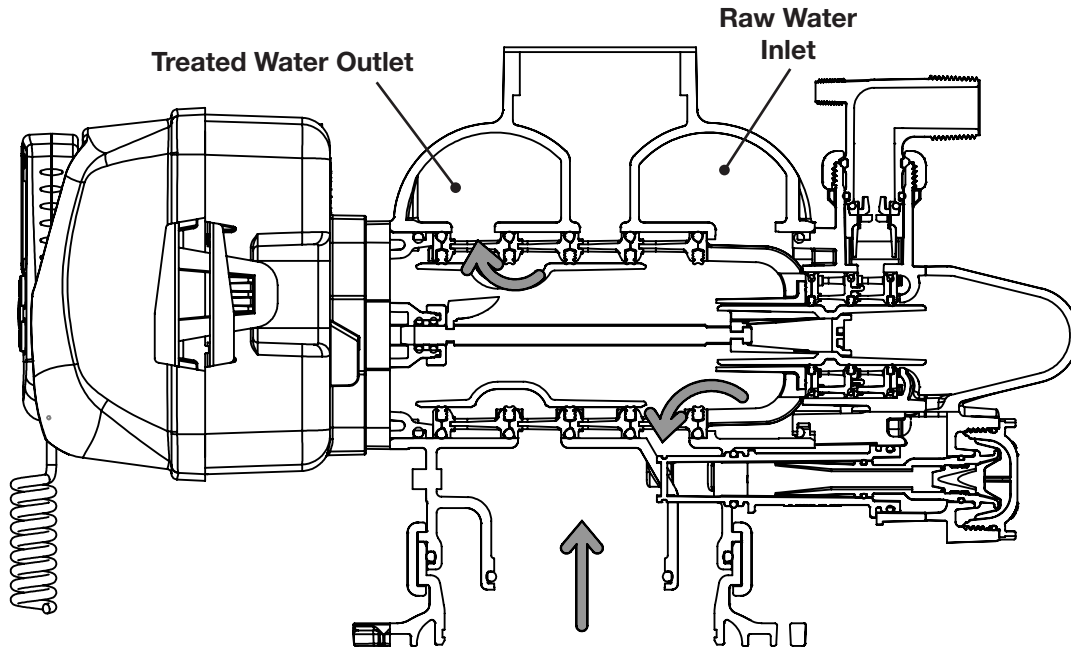

BACKWASH

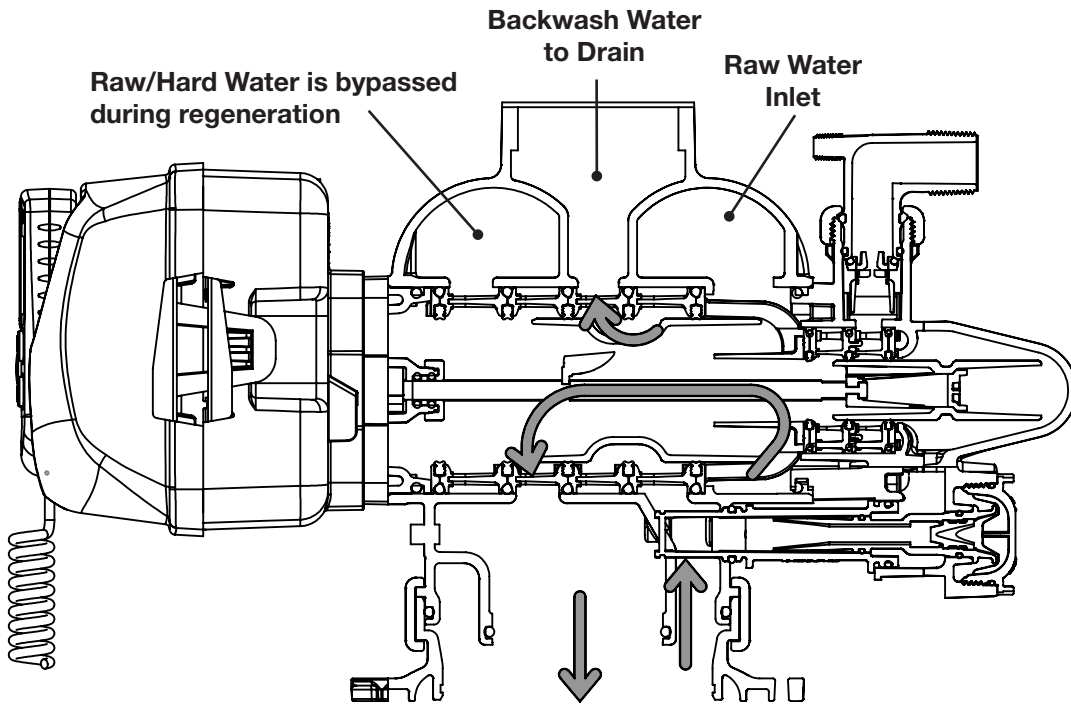

CYCLE POSITIONS / FLOW DIAGRAMS (CONTINUED)

DRAW

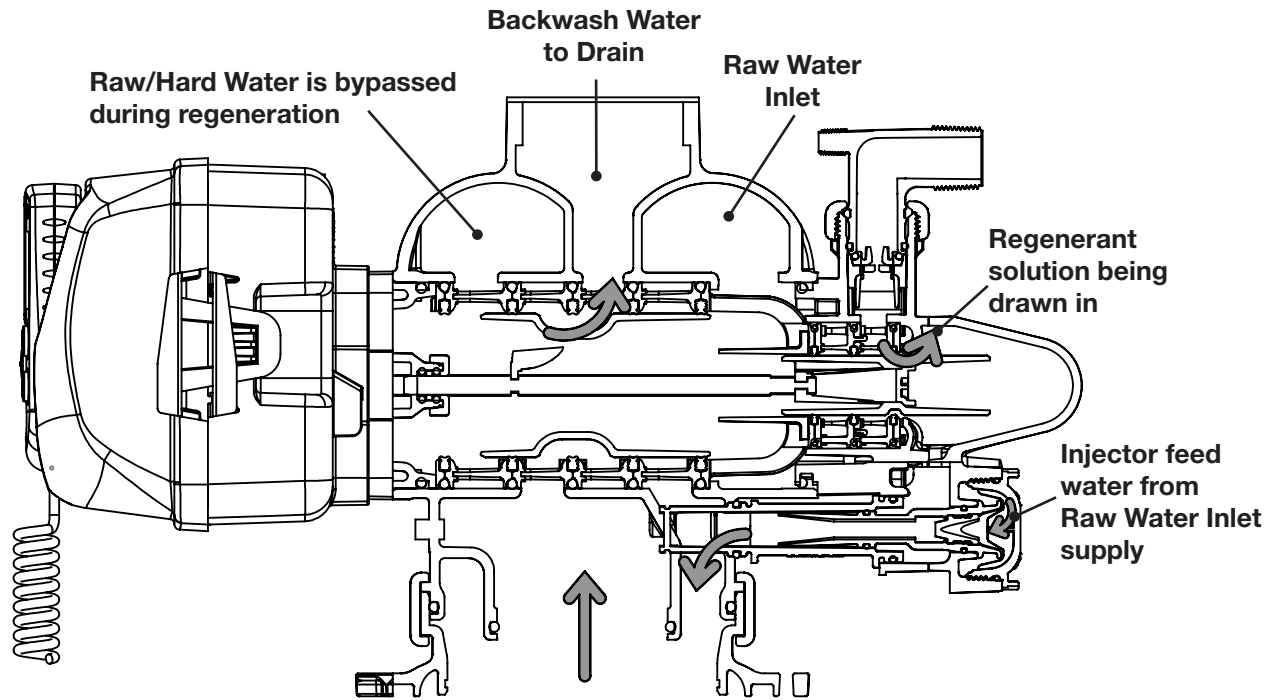

SLOW RINSE

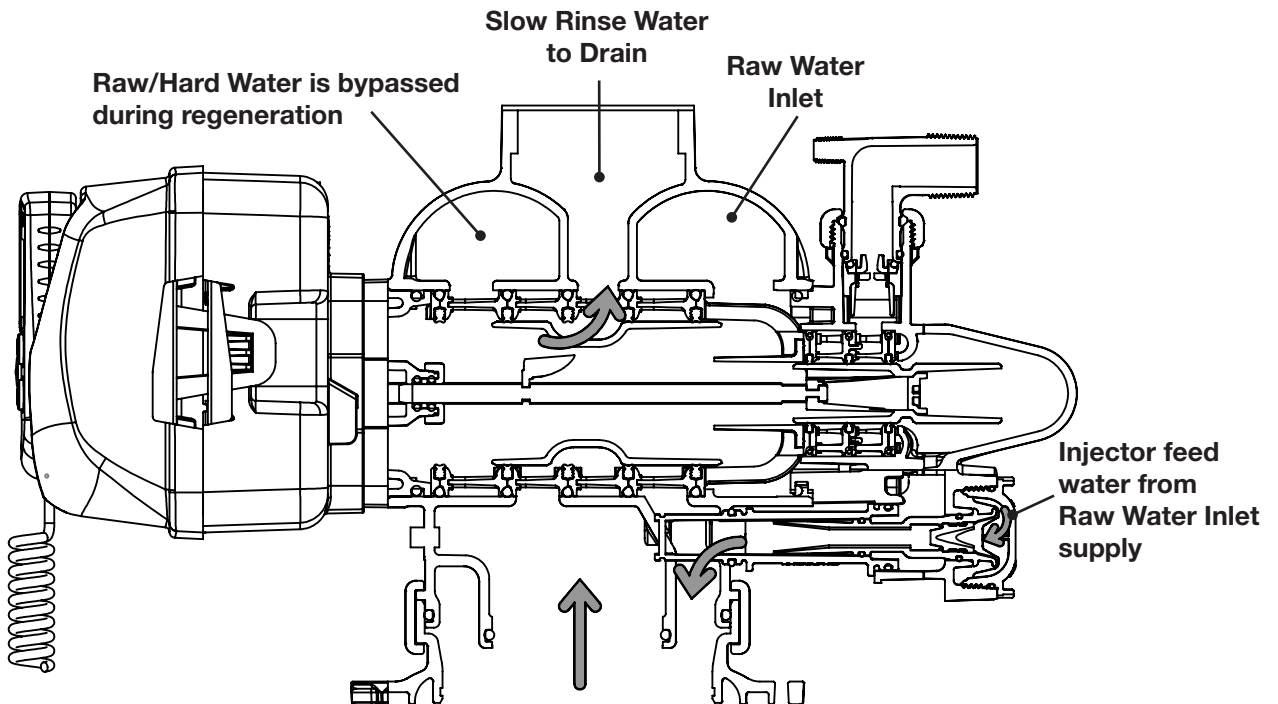

CYCLE POSITIONS / FLOW DIAGRAMS (CONTINUED)

RINSE

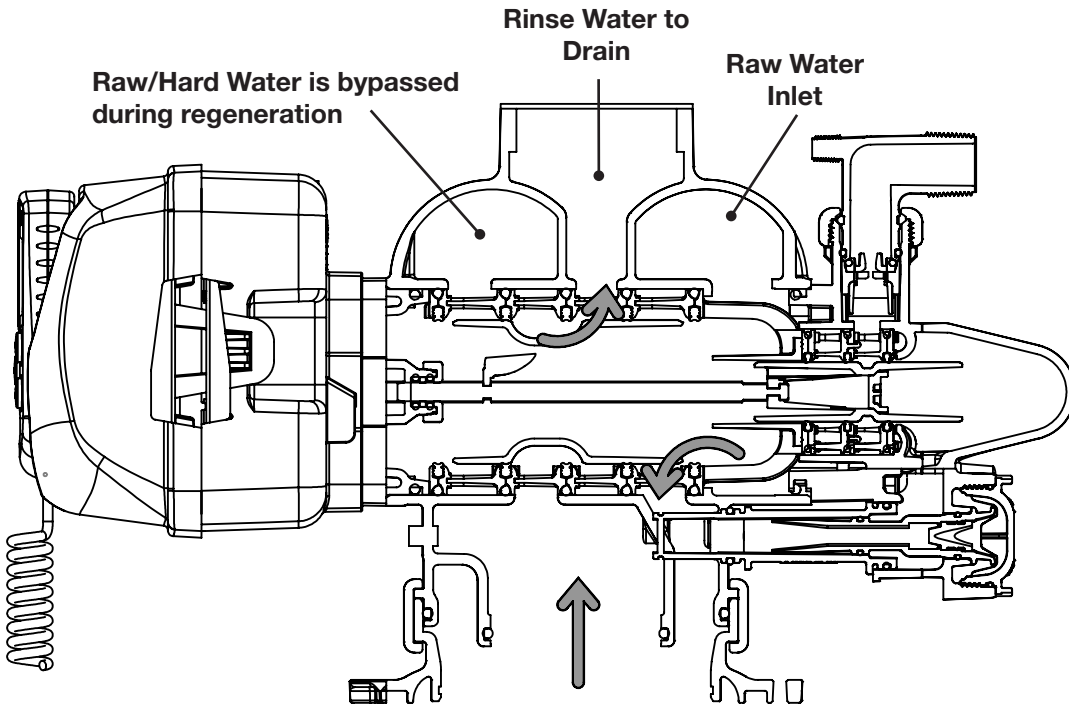

SOFT WATER REFILL

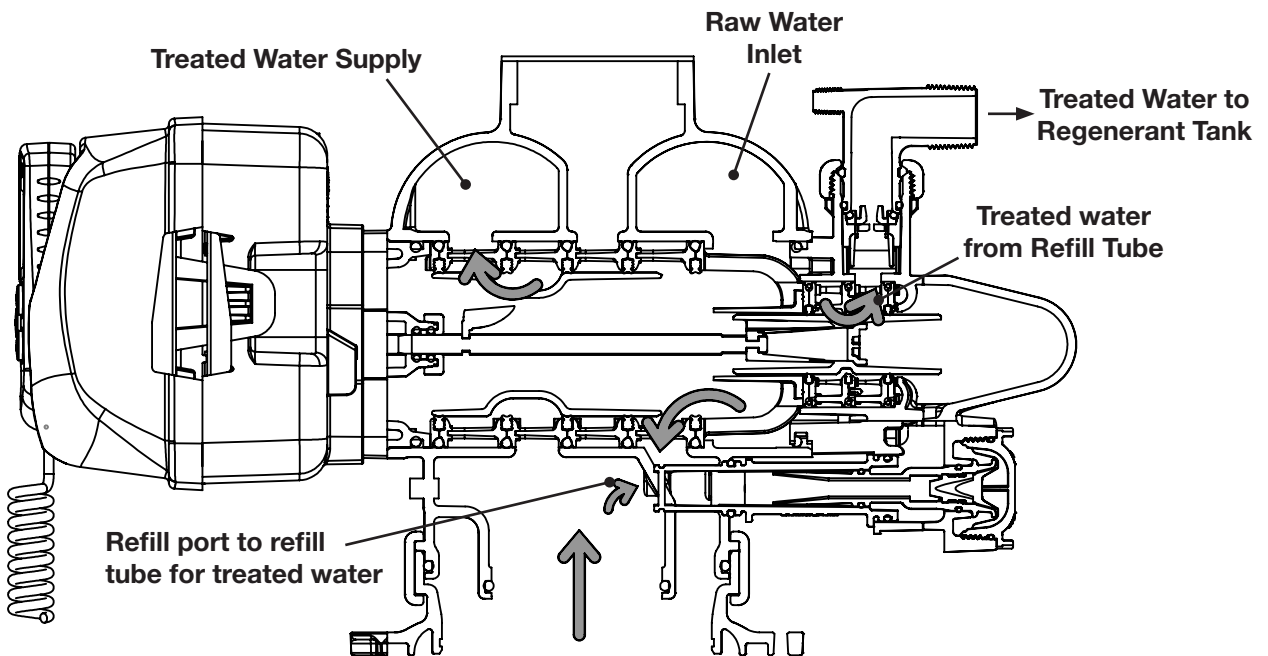

FRONT COVER AND DRIVE ASSEMBLY

Drawing No.	Order No.	Description	Quantity
1	V3068-01	WS2H/3 POD FRONT/BACK COVERS	1
1a	V3082-01	WS2H/3 GRAPHICS POD ASY W/BRD*	Optional
2	V3241-02BOARD	WS2H/3 DISPLAY GRPH POD PCB REPL	1
3	V3248-01	WS2H/3 GRAPHICS POD CABLE	1
4	V3242-03BOARD	WS2H/3 VLV W/ MODBUS PCB REPL	1
5	V3224-01R	WS2H/3 COVER ASY PLATINUM	1
6	V3107-01	WS1 MOTOR ASY	1
7	V3226-01	WS2H/3 DRIVE BRACKET ASY	1
8	V3110	WS1 DRIVE GEAR 12X36	3
9	V3109	WS1 DRIVE GEAR COVER	1
Not Shown	V3461-02	WS2H/3 24VDC 0.8A PWR SUPPLY	1
	V3461EU-02	WS2H/3 24VDC 0.8A EU PWRSUPPLY	
	V3461UK-02	WS2H/3 24VDC 0.8A UK PWRSUPPLY	
10	V4427	WS2H/3 PCB RELAY EXP KIT	Optional

*Contains items 1,2 & 3 Pod Assembly, PC Board and Cable

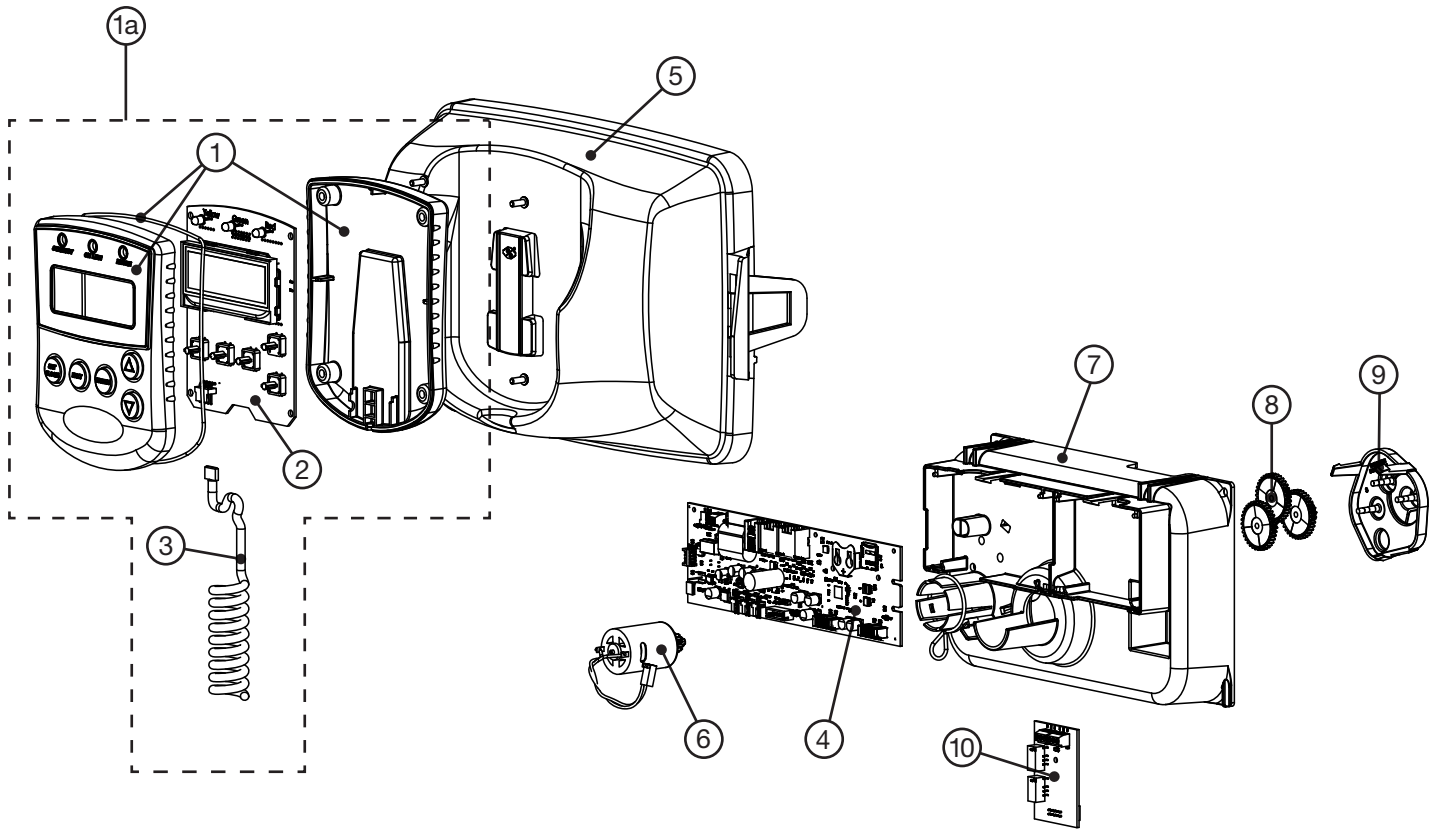

DRIVE CAP ASSEMBLY, DOWNFLOW PISTON, REGENERANT PISTON, SPACER STACK ASSEMBLY, DRIVE BACKPLATE AND MAIN BODY

Drawing No.	Order No.			Description	Quantity
	2H	2HF	3"		
1	V3275			3/8-16 x 2 1/4 SS Screw	4
2	V3291			3/8 Washer SS	4
3	V3225			Backplate	1
4	V3066	V3093		Drive Assembly	1
5	V3289			Drive Cap O-ring	1
6	V3204-01	V3666-01		Main Piston	1
7	V3238-01***			Brine Piston	1
8	V3065	V3092		Seal Spacer Stack	1
Not Shown	V3468-04			1/4" Plug, NPT	2
	V3465-04			1/4" Plug, BSPT	
9	V3201-03	V3201-01HF	V3667-03	Main Body, NPT	1
	V3201BSPT-03	V3201BSPT-01HF	V3667BSPT-03	Main Body, BSPT	
10	V3279		V3763	Base O-ring	1
11	V3280		V3762	Riser O-ring NPT	1
	V3452			Riser O-ring BSPT	
12	V3054**		V3091**	Base Clamp Assembly	1
13	V3276			Base Clamp Bolt 5/16-18 x 1 3/4 SS	1
14	V3269			Hex Nut 5/16-18 SS	1

**V3054 and V3091 WS2 4 IN BASE CLAMP ASY includes a V3276 WS2 BOLT HEX SS 5/16-18X1-3/4 and V3269 WS2 NUT 5/16-18 SS HEX.

***V3238-01 Brine Piston is used for Backwash Only valves.

THIS WATER METER SHOULD NOT BE USED AS THE PRIMARY MONITORING DEVICE FOR CRITICAL OR HEALTH EFFECT APPLICATIONS.

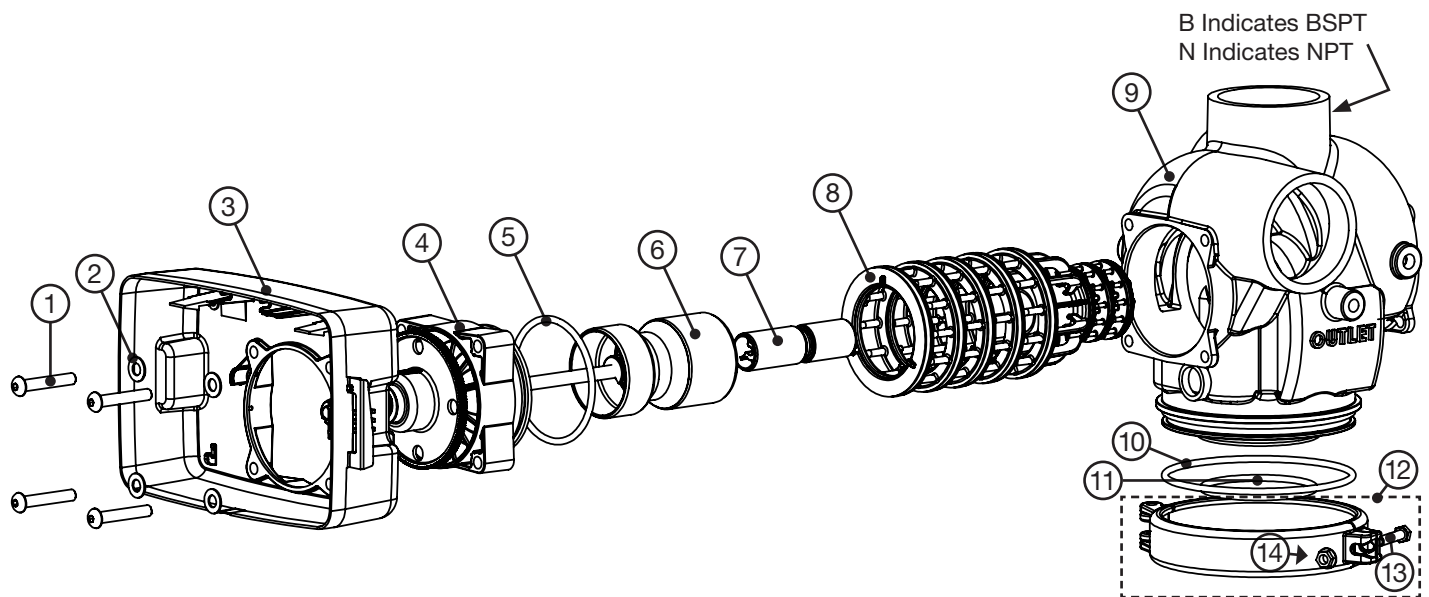

INLINE FLOW METER ASSEMBLY

Drawing No.	Order No.			Description	Quantity
	2H	2HF	3"		
	V3003-02	See Meter Instructions			
1	V3118-03			WS1.5/2H Meter Commercial Asy	1
2	V3632			Commercial Meter Retaining Clip	1
3	V3118-03			Turbine Asy	1
4	V3501			Commercial Meter Turbine Clip	1
5	V3105			O-ring - 215	1

Service or replace the turbine by:

1. Turn the bypass for the system off and relieve the pressure on the system.
2. Press downward on the remote meter assembly to relieve tension on the retaining clip V3632 (or the U-shaped V3223 WS2 Meter Clip). Remove the clip and take the meter assembly out of the housing.
3. Remove the bend from the two exposed tips of the retaining clip V3501 and remove clip.
4. Service or replace the V3118-03 WS15/2 Turbine Assembly and place it back in the turbine shaft.
5. Insert the V3501 WS15/2 Turbine Clip and re-bend the exposed ends of the clip. The V3118-03 turbine has a groove to line up with the V3501 WS15/2 Turbine Clip.
6. Insert meter assembly back into the meter housing.
7. Re-install the meter retaining clip V3632 as shown below (or the U-shaped V3223 WS2 Meter Clip).
8. Open the bypass for the system slowly to bring back into service and check to be sure you have no water leaks.

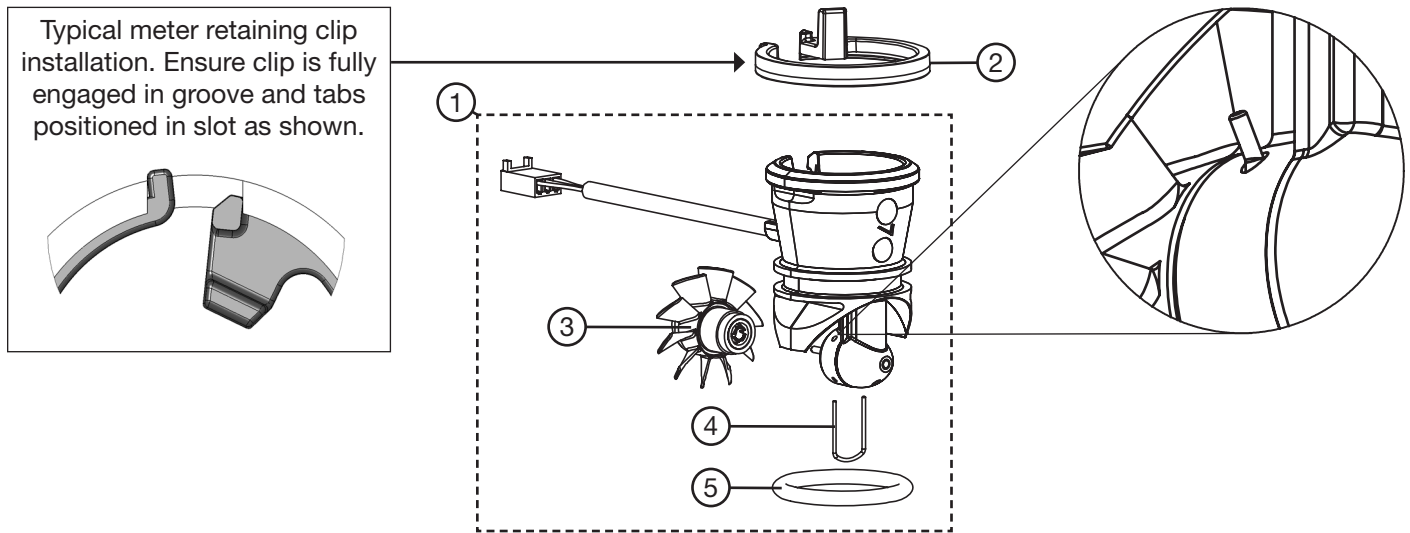

WS2H, WS2HF, AND WS3 BRINE VALVE BODY AND INJECTOR COMPONENTS

Drawing No.	Order No.	Description	Quantity
1	V3237-01	WS2H/3 SOFTFILL TUBE ASY	1
2	V3236-04*	WS2H INJECTOR TUBE ASY FOR A THRU H	1
3	V3289	O-RING 344	1
4	V3067	WS2H/3 BRINE BODY ASY	1
5	V3477	WS2H/3 INJECTOR CAP	1
6	V3152	O-RING 135	1
7	V3275	WS2H/3 SCREW BSHD SS 3/8-16X2-1/4 (7/32" hex allen wrench required)	4
8	V3291	WS2H/3 WASHER SS 3/8	4
9	V3162-022**	WS1 DLFC 022 FOR 3/4	1
10	V3231	WS2H/3 REFILL FLOW CNTRL RETAINER	1
11	V3277	O-RING 211	1
12	V3105	O-RING 215	1
13	V3150	WS1 SPLIT RING	1
14	V3151	WS1 NUT 1 QC	1
15	V3149	WS1 FTG 1 MALE NPT ELBOW	NPT Only
	V3797	WS1 FTG 1 MALE BSPT ELBOW	BSPT Only
16	V3010-XX	See WS2H and WS3 Valve Injector Order Information table below ²	1
17	V3499***	WS2H/3 FITTING CAP 1 IN THREADED	1
Not Shown	V3189	WS1 FTG 3/4&1 PVC SLVNT 90	Optional

* V3236-04 WS2H INJECTOR TUBE ASY A thru H contains a V3285 O-RING 213 and a V3286 O-RING 216. WS3 BSPT valves manufactured before January 7, 2021 and WS3 NPT valves manufactured before August 25, 2021 use a V3670-01 Injector Tube. V3670-01 WS3 INJECTOR TUBE DOWNFLOW ASY contains a V3285 O-RING 213, V3286 O-RING 216 and a V3163 O-RING 019.

** Any V3162-XXX flow control may be used. V3237-01 WS2H SOFTFILL TUBE ASY contains a V3155 O-RING 112, V3287 O-RING 110 and a V3288 O-RING 206.

*** Install V3499 on V3149 if valve is to be set up as a backwash only valve.

WS2H AND WS3 VALVE INJECTOR ORDER INFORMATION

Injector Order Number	Typical Tank Diameter ¹
V3010-2A	18"
V3010-2B	21"
V3010-2C	24"
V3010-2D	30"
V3010-2E	36"
V3010-2F	42"
V3010-2G	48"
V3010-2H	63"

¹ Actual injector size used may vary depending on the design and application of the system. Injectors in table are sized for a typical downflow softener using standard mesh synthetic cation exchange media regenerating with sodium chloride.

² V3010-2A through V3010-2G injectors contain a V3283 O-RING 117 and a V3284 O-RING 114. V3010-2H injectors use a V3283 O-RING 117 and D1263 O-RING 116. Backwash Only Valves include a V3499 but do not include the following parts: V3189, V3162-022, V3231 and V3277.

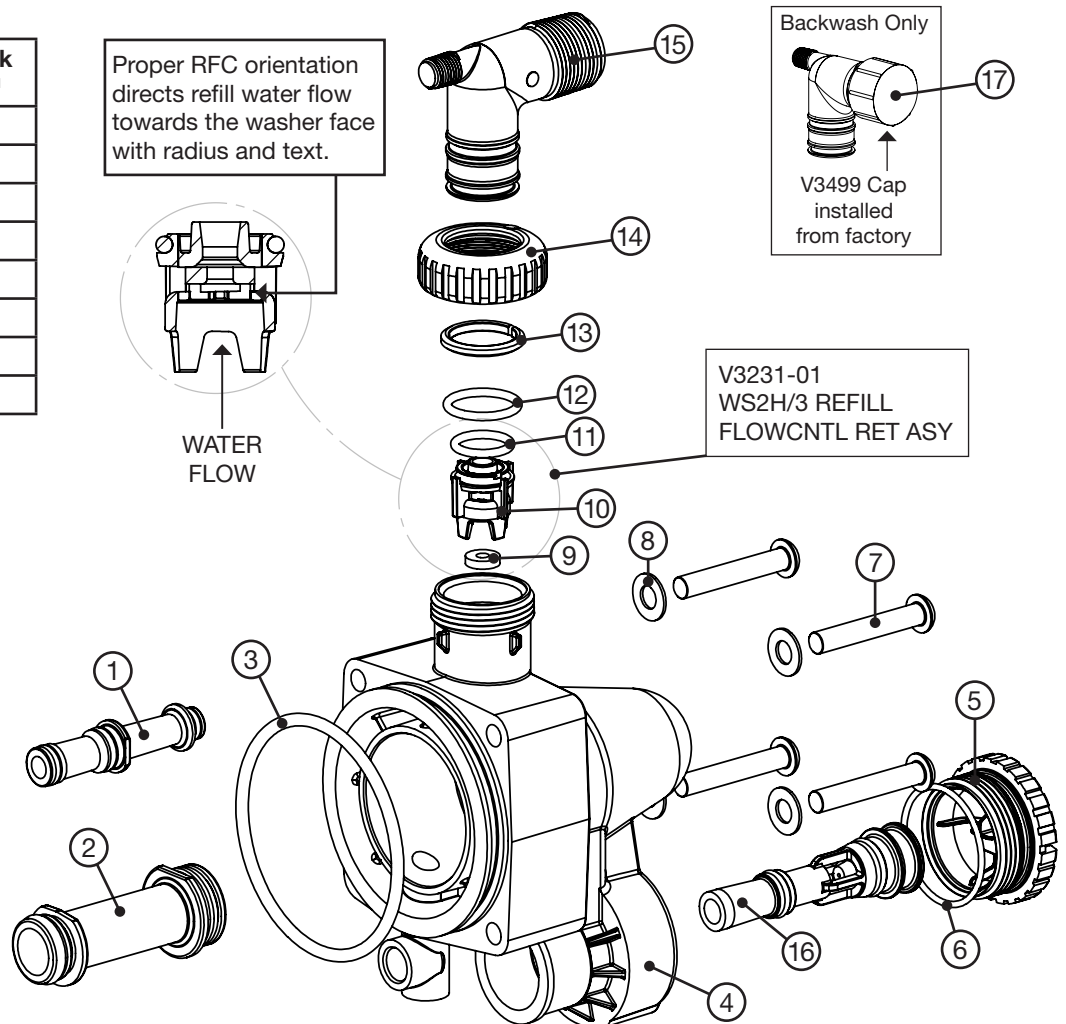

STANDARD INJECTOR GRAPHS

Order No. V3010-2A
US Units

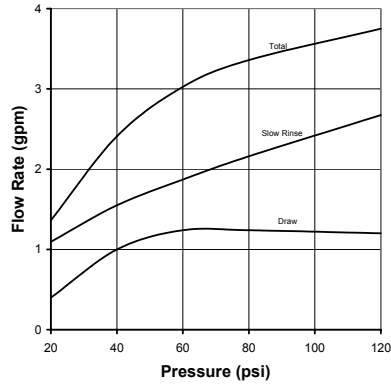

Order No. V3010-2B
US Units

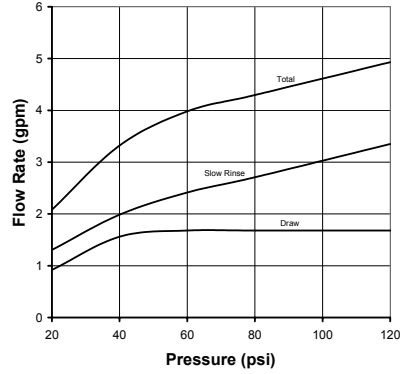

Order No. V3010-2C
US Units

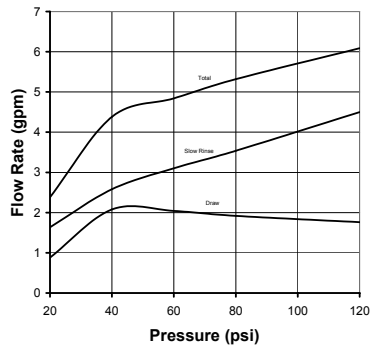

Order No. V3010-2D
US Units

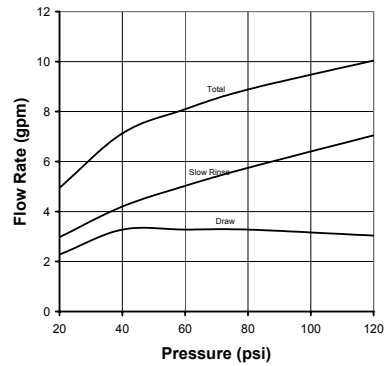

Order No. V3010-2E
US Units

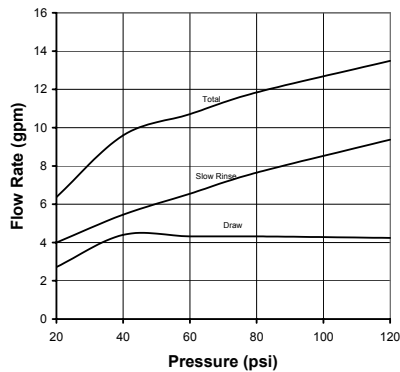

Order No. V3010-2F
US Units

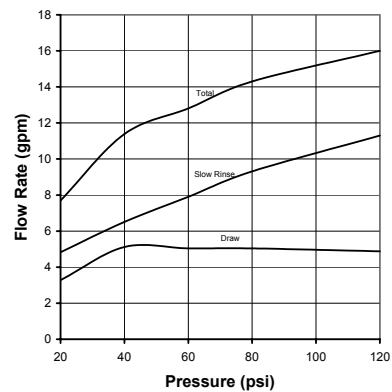

Order No. V3010-2G
US Units

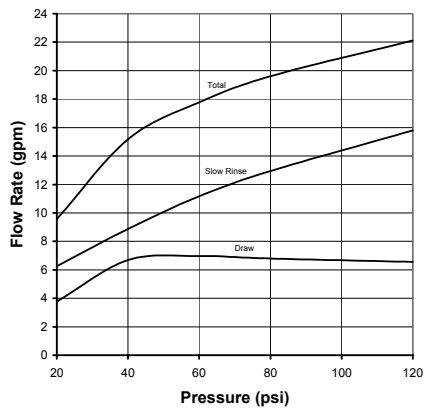

Order No. V3010-2H
US Units

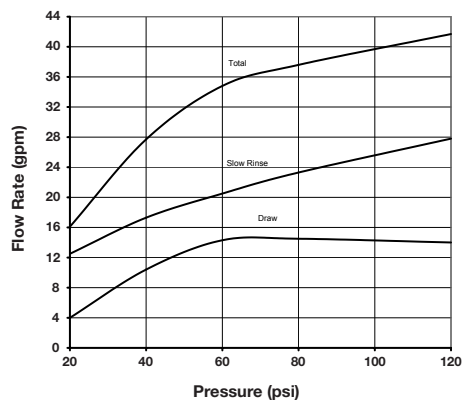

STANDARD INJECTOR GRAPHS (CONTINUED)

**Order No. V3010-2A
Metric Units**

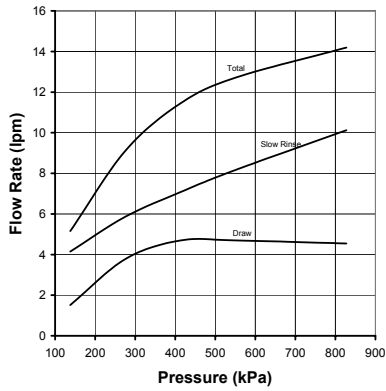

**Order No. V3010-2B
Metric Units**

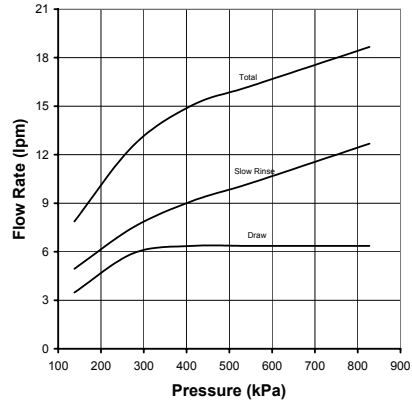

**Order No. V3010-2C
Metric Units**

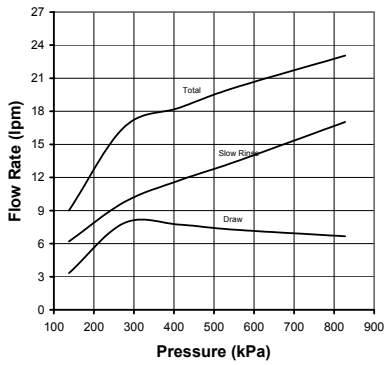

**Order No. V3010-2D
Metric Units**

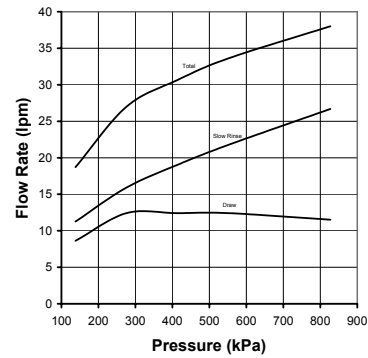

**Order No. V3010-2E
Metric Units**

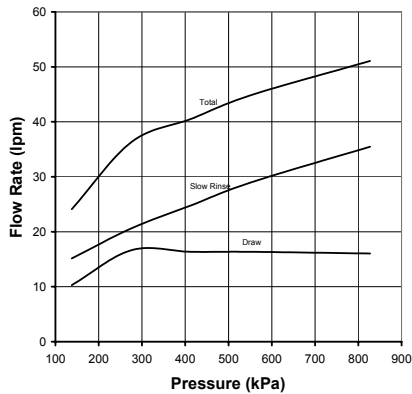

**Order No. V3010-2F
Metric Units**

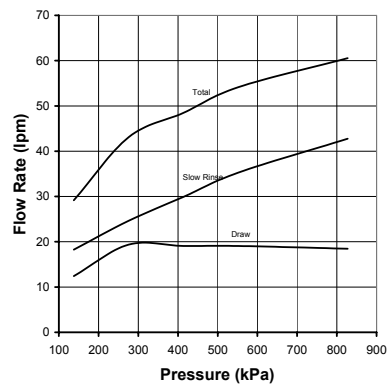

**Order No. V3010-2G
Metric Units**

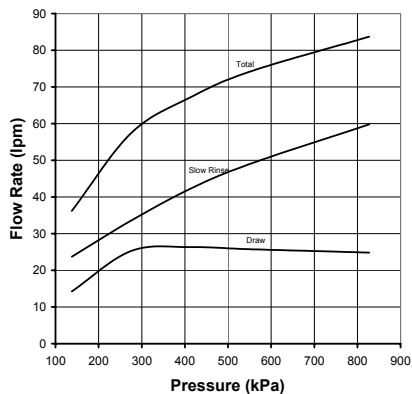

**Order No. V3010-2H
Metric Units**

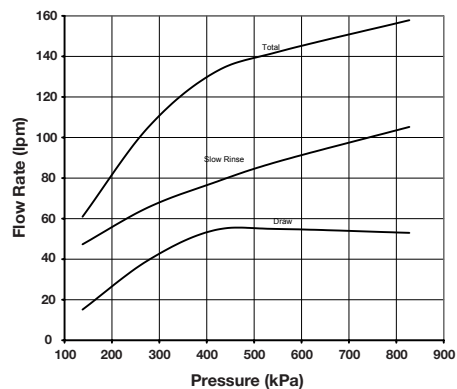

BASES

V3064 WS2H/2QC 4 INCH BASE ASY (FOR USE ON WS2H OR WS2QC ONLY)

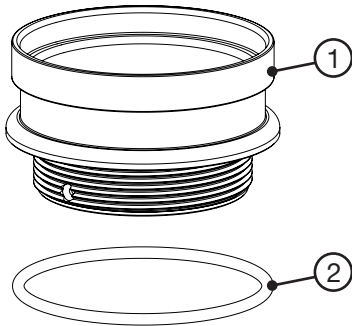

Drawing No.	Order No.	Description	Quantity
1	V3202-01	WS2H BASE	1
2	V3419	O-RING 347	1

V3055 WS2H/2QC 6 INCH FLANGE BASE ASY or V3090 WS3 6 INCH FLANGE BASE ASY

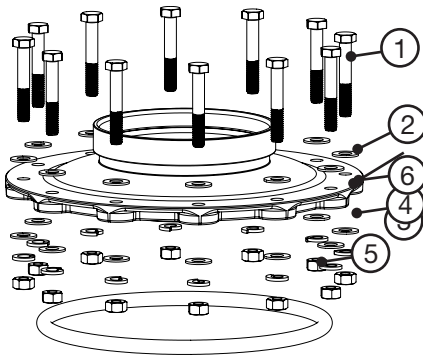

Drawing No.	Order No.	Description	Quantity	
			V3055	V3090
1	V3444	WS2H SCREW HEXCAP 5/16-18X2 SS	12	12
2	V3293	WS2H WASHER SS 5/16 FLAT	24	24
3	V3445	WS2H WASHER SPLIT LOCK 5/16 SS	12	12
4	V3447	NUT HEX 5/16-18 SILICON BRASS	12	12
5	COR60FL	O RING 6 FLANGE ADAPTER	1	1
6	V3261-01	WS2H FLANGE BASE	1	
	V3671-01	WS3 FLANGE BASE		1

UPPER DIFFUSERS

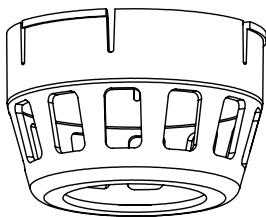

Order No.	Description
D1300-01	2" RISER DIFFUSER
V3672	3" RISER UPPER DIFFUSER

SIDE MOUNT BASE ASSEMBLY

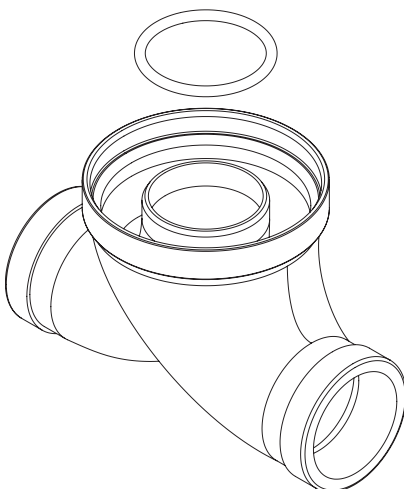

Order No.	Description	Inlet/Outlet
V3260-02	2" Sidemount, NPT	2" Female NPT or 2.5" Groove Lock
V3260BSPT-02	2" Sidemount, BSPT	2" Female BSPT or 2.5" Groove Lock
V3674-02	3" Sidemount, NPT	3" Female NPT
V3674BSPT-02	3" Sidemount, BSPT	3" Female BSPT

When using a side mount base with WS2H, WS2QC, or WS2HF BSPT valves replace distributor pilot O-ring V3452 O-RING 230 with V3280 O-RING 332. See exploded view of WS2H, WS2QC, or WS2HF valve for specific location of distributor pilot O-ring.

DRAIN LINE FLOW CONTROLS

All drain line flow control housings are shipped without flow control washers.

See drain line flow control washer section for available flow selections.

PVC Elbow, 0.7 - 10 GPM

Inline Plastic, 9 - 25 GPM

Item	Part#	Description	Qty.
	V3158-04	WS Drain Fitting, 3/4" Elbow	
1	V3158-03	Drain Elbow, 3/4 NPT	1
2	V3159-01	DLFC Retainer Assembly	1
3	V3163	O-ring, -019	1
4	H4615	Locking Clip	1
5*	V3983	WS2 DLFC Adapter	1
6	V3162-xx	See DLFC Section	1

Item	Part#	Description	Qty.
	V3008-05	WS Drain Fitting, 1" Straight	
1	V3167	WS Drain Fitting Adapter, 1" NPT	1
2	V3166-01	Drain Fitting Body	1
3	V3151	WS1 Nut, QC	1
4	V3150	WS1 Split Ring	1
5	V3105	O-ring -215	1
6	V3163	O-ring -019	1
7	H4615	Locking Clip	1
8**	V3983	WS2 DLFC Adapter	1
9	V3190-xx	See DLFC Section	1

*Also available: V3414 WS1.5 DLFC Adapter

**Also available: V3414 WS1.5 DLFC Adapter

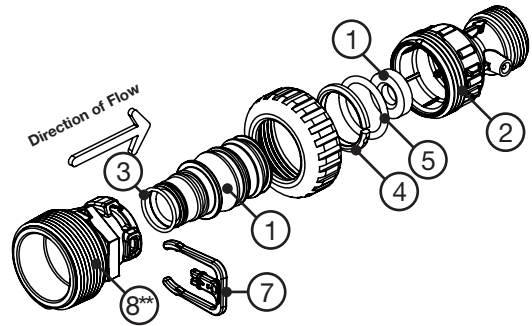
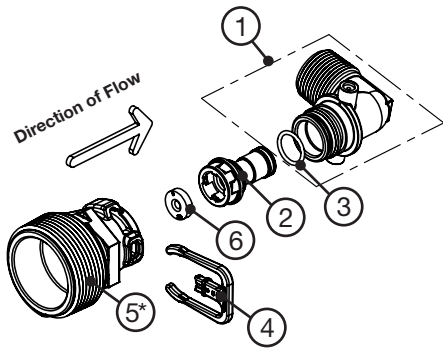

Stainless Steel, 9 - 85 GPM

Drawing No.	Order No.	Description	Quantity			
			V3079	V3079BSPT	V3080	V3080BSPT
1	V3081	WS15 RETAINER DLFC ASY	1	1	1	1
2	V3645	WS15 DLFC FLANGE OUTLET FNPT	1		1	
	V3645BSPT	WS15 DLFC FLANGE OUTLET FBSPT		1		1
3	V3646	WS15 DLFC FLANGE INLET MNPT			1	1
4	V3388	WS125 DLFC FLANGE INLET MNPT	1	1		
5	V3652	B S 5/16-18x3/4	4	4	4	4
6	V3441	O-RING 226	1	1	1	1
7	V3162-xx	See DLFC Table	0-6	0-6	0-6	0-6
8	V3190-xx	See DLFC Table	1	1	1	1

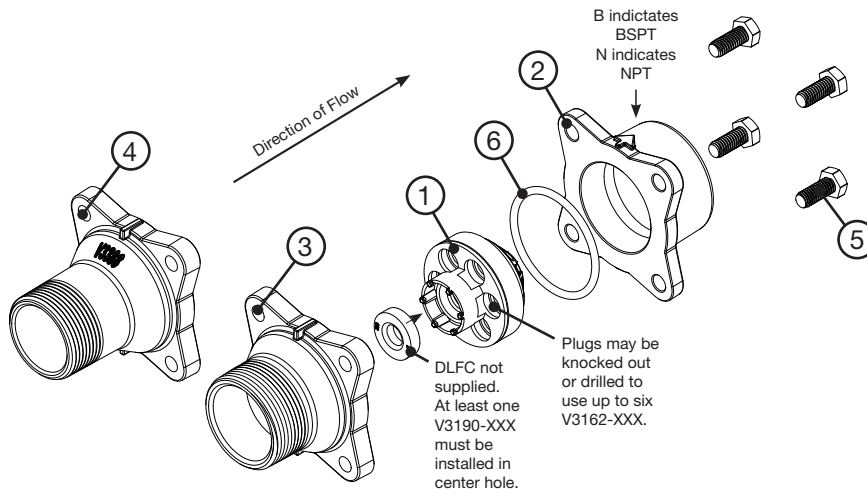

M X F STAINLESS STEEL, 0.7 – 150 GPM

Drawing No.	Order No.	Description	Quantity	
			V3051	V3051BSPT
1	V3052	WS2 DLFC Retainer Asy	1	1
2	V3245	WS2 DLFC Flange Inlet NPT	1	
	V3245BSPT	WS2 DLFC Flange Inlet BSPT		1
3	V3246	WS2 DLFC Flange Outlet NPT	1	
	V3246BSPT	WS2 DLFC Flange Outlet BSPT		1
4	V3273	Bolt Hex Hd S/S HCS 3/8-16x3/4	4	4
5	V3278	O-ring 338	1	1
6	V3162-XX	See DLFC table	0-5	0-5
7	V3190-XX	See DLFC table	0-4	0-4

Assemblies are shipped without drain line flow control (DLFC). Assembly instructions:

1. Determine the desired flowrate. Select a combination of V3162-XXX's and V3190-XXX's to arrive at the desired flow rate. Up to five of the smaller V3162-XXX's may be used. Up to four of the larger V3190-XXX's may be used.
2. Using a drill or punch, remove the desired knockout(s) in V3052.
3. Smooth hole(s).
4. Install appropriate size(s) of drain line flow control washers. Pay close attention to proper DLFC orientation.
5. Assemble. Properly orient the V3052 in the direction of flow.
6. Inlet and outlet threads are 2". Couplings for iron pipe may also be used.

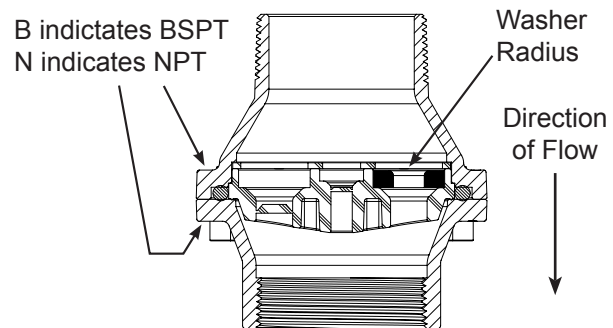
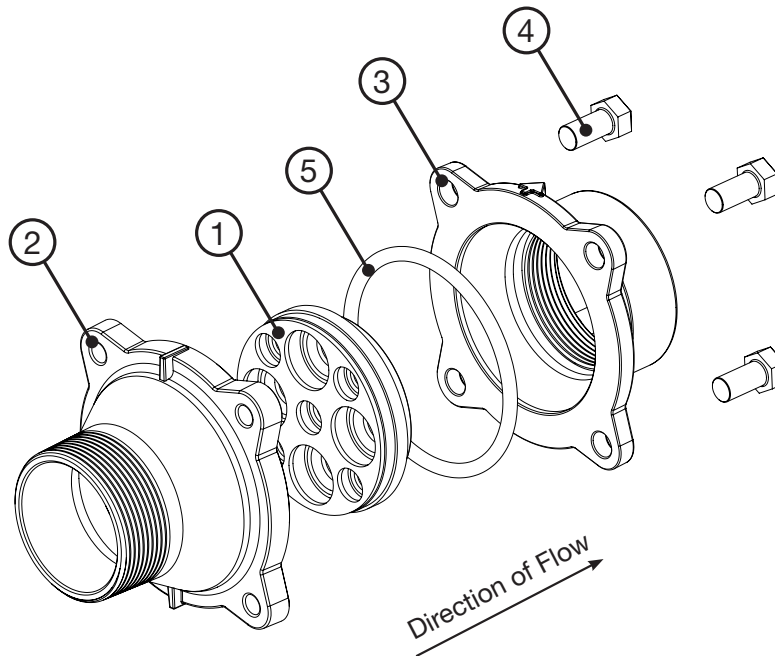

MXF STAINLESS STEEL, 9-225 GPM

Drawing No.	Order No.	Description	Quantity	
			V3764	V3764BSPT
1	V3765-01	WS3 DLFC HOUSING NPT	1	
	V3765BSPT-01	WS3 DLFC HOUSING BSPT		1
2	V3766	WS3 DLFC RETAINER	1	1
3	V3767	WS3 DLFC RETAINER COVER	1	1
4	V3768	WS3 DLFC RETAINER RING	1	1
5	V3769	O-RING 336	1-2	1-2
6	V3190-XX	See DLFC table	1-9	1-9

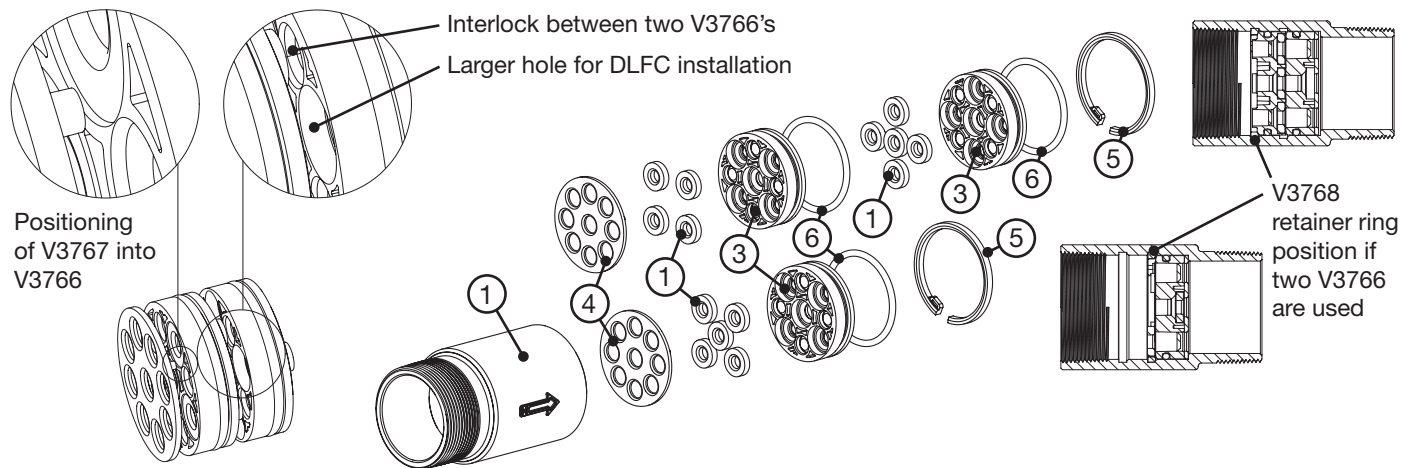

Assemblies are shipped without drain line flow control (DLFC) washers.

Assembly instructions:

1. Determine the desired flow rate. Select a combination of V3190-XXX's to arrive at the desired flow rate.
2. Using a drill or punch, remove the desired knockout(s) in V3766. Each V3766 retainer contains two types of knock outs. The larger knockouts are removed to install a DLFC. If two V3766 retainers are needed, remove the smaller diameter knockout that lines up with the DLFC installed in the other retainer. One or two V3766 retainers may be used. When using one V3766 retainer, V3190-XXX must be installed in the center hole. When using two V3766 retainers, a V3190-XXX must be installed in the center hole of one of the retainers and the center hole on the other retainer must remain open.
3. Smooth hole(s).
4. Install appropriate size(s) of drain line flow control washers. Pay close attention to proper DLFC orientation.
5. Assemble. Each V3766 retainer, must have a V3769 O-ring installed. One each of the V3767 retainer cover and V3768 retainer ring must be used whether one or two V3766 retainers are used. The positioning of the V3768 retainer ring varies depending on the number of V3766 retainer(s) used. Properly orient the V3766(s) in the direction of flow.
6. Properly orient the complete assembly in the direction of flow. Inlet and outlet threads are 3".

DRAIN LINE FLOW CONTROL WASHERS

Order No.	Description
V3162-007	0.7 GPM Drain line flow control
V3162-010	1.0 GPM Drain line flow control
V3162-013	1.3 GPM Drain line flow control
V3162-017	1.7 GPM Drain line flow control
V3162-022	2.2 GPM Drain line flow control
V3162-027	2.7 GPM Drain line flow control
V3162-032	3.2 GPM Drain line flow control
V3162-042	4.2 GPM Drain line flow control
V3162-053	5.3 GPM Drain line flow control
V3162-065	6.5 GPM Drain line flow control
V3162-075	7.5 GPM Drain line flow control
V3162-090	9.0 GPM Drain line flow control
V3162-100	10.0 GPM Drain line flow control
V3190-090	9.0 GPM Drain line flow control
V3190-100	10.0 GPM Drain line flow control
V3190-110	11.0 GPM Drain line flow control
V3190-130	13.0 GPM Drain line flow control
V3190-150	15.0 GPM Drain line flow control
V3190-170	17.0 GPM Drain line flow control
V3190-200	20.0 GPM Drain line flow control
V3190-250	25.0 GPM Drain line flow control

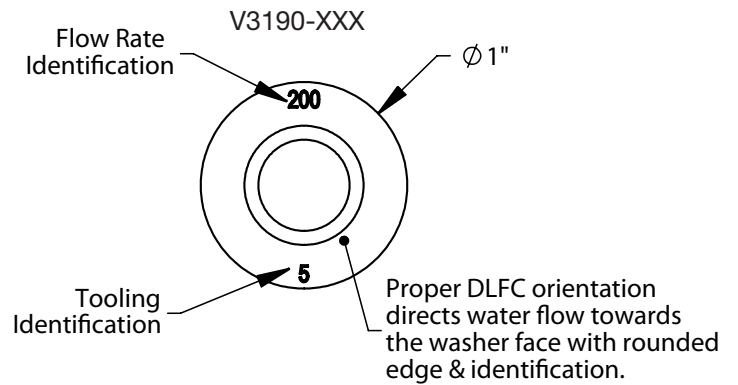
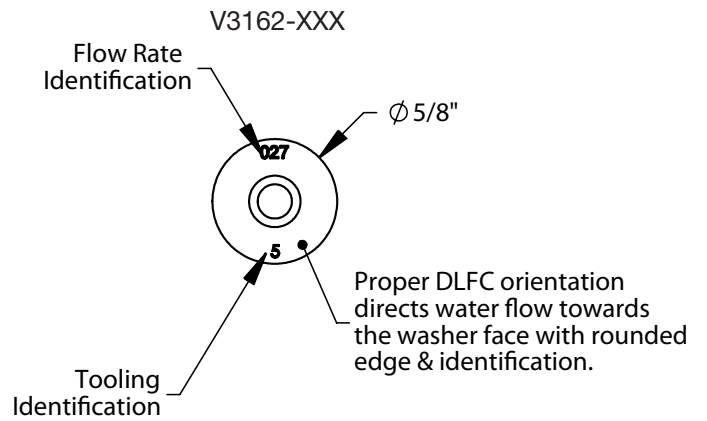

All DLFC housings ship without DLFC installed. Select control from table for proper backwash, based on media manufacturer's recommendations.

WS2H, WS2HF, AND WS3 TROUBLESHOOTING GUIDE**WS2H, WS2HF, and WS3 Error Codes**

Possible Errors	
Code	Description
1001	No Encoder Pulses
1002	Unexpected Stall, Main Drive
1003	Run Time Too Long, Main Drive
14001	Message Queue Full
15003	Run Time Too Long, Bypass Drive
15010	Run Time Too Short, Bypass Drive Could Not Drive Offline
15011	Run Time Too Short, Bypass Drive Could Not Drive Online
16001	Communication Lost With Unit 2
16002	Communication Lost With Unit 3
16003	Communication Lost With Unit 4
18000	Reset Performed
18001	Power Loss
18002	Power Restored
20001	Run time too long, AUX drive
20002	Run time too short during unwind, AUX drive
20011	Run time too short, AUX drive
21XXX	System recovery from memory error

Problem	Possible Cause	Solution
1. No Display on POD	<ul style="list-style-type: none"> a. No power at electric outlet b. Control valve Power Adapter not plugged into outlet or power cord end not connected to PC board c. Improper power supply d. Poor connection between POD connector and PC Board. e. Defective Power Adapter f. Defective PC Board 	<ul style="list-style-type: none"> a. Repair outlet or use working outlet b. Plug Power Adapter into outlet or connect power cord end to PC Board connection c. Verify proper voltage is being delivered to PC Board d. Check connector on POD, possible broken wire or terminal pin not inserted properly in connector. Clean pins on PC Board by plugging and unplugging the POD connector a few times to remove excess protective coating. e. Replace Power Adapter f. Replace PC Board
2. POD does not display correct time of day	<ul style="list-style-type: none"> a. Power Adapter plugged into electric outlet controlled by light switch b. Tripped breaker switch and/or tripped GFI c. Power outage d. Defective PC Board 	<ul style="list-style-type: none"> a. Use uninterrupted outlet b. Reset breaker switch and/ or GFI switch c. Reset time of day d. Replace PC Board
3. Display does not indicate that water is flowing. Refer to user instructions for how the display indicates water is flowing	<ul style="list-style-type: none"> a. Bypass/ isolation valve in bypass position b. Meter is not connected to meter connection on PC Board c. Restricted/ stalled meter turbine d. Meter wire not installed securely into three pin connector e. Defective meter f. Defective PC Board 	<ul style="list-style-type: none"> a. Turn bypass/isolation handles to place in service position b. Connect meter to three pin connection labeled FLOW on PC Board c. Remove meter and check for rotation or foreign material d. Verify meter cable wires are installed securely into three pin connector labeled FLOW e. Replace meter f. Replace PC Board
4. Control valve regenerates at wrong time of day	<ul style="list-style-type: none"> a. Power outage b. Time of day not set correctly c. Time of regeneration set incorrectly d. Control valve set at "on 0" (immediate regeneration) 	<ul style="list-style-type: none"> a. Reset time of day. b. Reset to correct time of day c. Reset regeneration time d. Check programming setting and reset to dEL (for a delayed regen time)
5. Time of day flashes on and off	<ul style="list-style-type: none"> a. Power outage occurred 	<ul style="list-style-type: none"> a. Test voltage of Lithium Coin Cell Battery (new battery 3.0v+, dead battery 2.75vdc). Replace battery if needed and reset time of day.
6. Control valve does not regenerate automatically when the REGEN button is depressed and held.	<ul style="list-style-type: none"> a. Defective PC Board b. For the case of systems, another unit in regen would not allow another unit to go into regeneration 	<ul style="list-style-type: none"> a. Replace PC Board b. Wait for unit in regeneration to finish

Problem	Possible Cause	Solution
7. Control valve does not regenerate automatically but does regenerate when the REGEN button is depressed and held.	<ul style="list-style-type: none"> a. Bypass/isolation valves in bypass position b. Meter is not connected to meter connection on PC Board c. Restricted/ stalled meter turbine d. Incorrect programming e. Meter wire not installed securely into three pin connectors f. Defective meter g. Defective PC Board 	<ul style="list-style-type: none"> a. Turn bypass/isolation valve's handles to place in service position b. Connect meter to three pin connection labeled FLOW on PC Board c. Remove meter and check for rotation or foreign material d. Check for programming error e. Verify meter cable wires are installed securely into three pin connector labeled FLOW f. Replace meter g. Replace PC Board
8. Hard or untreated water is being delivered	<p>Check water quality directly at unit outlet</p> <ul style="list-style-type: none"> 1) Water quality is good <ul style="list-style-type: none"> a) Bypass/isolation valves are open or faulty 2) Water quality is poor <ul style="list-style-type: none"> a) Damaged seal/stack assembly b) Faulty riser tube or seal c) Control valve body type and piston type mis-matched 3) Media is exhausted, water quality is poor <ul style="list-style-type: none"> a) Higher than anticipated water usage b) Meter not registering c) No regenerant or low level of regenerant in regenerant tank d) Control fails to draw in regenerant e) Water quality fluctuation f) Fouled media bed 	<ul style="list-style-type: none"> 1) External Bypass Leak <ul style="list-style-type: none"> a) Fully close bypass/isolation valves or replace 2) Internal Bypass Leak <ul style="list-style-type: none"> a) Replace seal/stack assembly b) Verify seal placement & engagement with riser c) Verify proper control valve body type and piston type match 3) No internal leaks <ul style="list-style-type: none"> a) Check program settings or diagnostics for abnormal water usage b) See Troubleshooting Guide #3 c) Check refill setting in programming. Check refill flow control for restrictions or debris and clean or replace, check refill flow control rate for proper fill time. d) Refer to Troubleshooting Guide #12 e) Test water and adjust program values accordingly f) Replace media bed
9. Control valve uses too much regenerant	<ul style="list-style-type: none"> a. Improper refill setting or refill flow control is not sized properly b. Improper program settings c. Control valve regenerates frequently 	<ul style="list-style-type: none"> a. Check refill setting and check refill flow control for proper refill rate. b. Check program setting to make sure they are specific to the water quality and application needs c. Check for leaking fixtures that may be exhausting capacity or system is undersized

Problem	Possible Cause	Solution
10. Residual regenerant being delivered to service	<ul style="list-style-type: none"> a. Low water pressure b. Plugged, fouled, or incorrect injector size c. Restricted drain line d. Damaged seal/ stack assembly or piston allowing leakage during draw e. Draw time too short f. Excessive refill g. Vacuum leak in draw line/elbow 	<ul style="list-style-type: none"> a. Check incoming water pressure – water pressure must remain at minimum of 25 psi b. Inspect and clean or replace injector, or replace injector with correct size for the application c. Check drain line for restrictions or debris and clean d. Check seal/stack assembly and piston for damage and replace e. Program proper draw time needed f. Program proper refill time needed g. Locate vacuum leak and fix
11. Excessive water in regenerant tank	<ul style="list-style-type: none"> 1) Tank is being overfilled <ul style="list-style-type: none"> a) Improper program settings b) Missing refill flow controller 2) Previous regenerant is not being drawn out 	<ul style="list-style-type: none"> 1) Excess from fill cycle <ul style="list-style-type: none"> a) Verify program settings b) Visual inspection / measure volume output into container 2) See Troubleshooting Guide #12
12. Control valve fails to draw in regenerant	<ul style="list-style-type: none"> a. Injector is plugged b. Faulty regenerant piston c. Regenerant line connection leak d. Drain line restriction or debris causes excess back pressure e. Drain line too long or too high f. Low water pressure g. Damaged seal/stack assembly 	<ul style="list-style-type: none"> a. Remove injector and clean or replace b. Replace regenerant piston c. Inspect regenerant line for air leak d. Inspect drain line and clean to correct restriction e. Shorten length and/or height f. Check incoming water pressure – water pressure must remain at minimum of 25 psi g. Inspect seal/stack assembly for damage and replace
13. Water running to drain	<ul style="list-style-type: none"> a. Power outage during regeneration or unit is currently in regeneration b. Damaged seal/stack assembly c. Piston assembly failure d. Drive cap assembly not tightened properly 	<ul style="list-style-type: none"> a. Upon power being restored, control will finish the remaining regeneration time. Reset time of day. b. Replace seal/stack assembly c. Replace piston assembly d. Re-tighten the drive cap assembly

Problem	Possible Cause	Solution
14. Err – 1001 = Control unable to sense motor movement	<ul style="list-style-type: none"> a. Motor not inserted fully to engage pinion, motor wires broken or disconnected b. PC Board not properly snapped into drive bracket c. Missing reduction gears d. Damaged or dirty reduction gear reflectors e. Faulty or dirty optics on back of PC board 	<ul style="list-style-type: none"> a. Disconnect power, make sure motor is fully engaged, check for broken wires, make sure two pin connector on motor is connected to the two pin connection on the PC Board labeled REGEN. Press NEXT and REGEN buttons for about 3 seconds to resynchronize software with piston position. b. Properly snap PC Board into drive bracket and then Press NEXT and REGEN buttons for about 3 seconds to resynchronize software with piston position. c. Replace missing gears d. Clean or replace reduction gear e. Clean or replace PC Board
15. Err – 1002 = Control valve motor ran too short and was unable to find the next cycle position and stalled	<ul style="list-style-type: none"> a. Foreign material is lodged in control valve b. Mechanical binding c. Main white drive gear too tight d. Improper voltage being delivered to PC Board 	<ul style="list-style-type: none"> a. Open up control valve and pull out piston assembly and seal/ stack assembly for inspection. Press NEXT and REGEN buttons for about 3 seconds to resynchronize software with piston position. b. Check piston and seal/ stack assembly, check reduction gears, check drive bracket and main drive gear interface. Press NEXT and REGEN buttons for about 3 seconds to resynchronize software with piston position. Check that pinion is not pressed up tight against motor. c. Loosen main drive gear. Press NEXT and REGEN buttons for about 3 seconds to resynchronize software with piston position. Verify free motion by rotating main drive gear by hand, driving piston in and out. d. Verify that proper voltage is being supplied. Press NEXT and REGEN buttons for about 3 seconds to resynchronize software with piston position.

Problem	Possible Cause	Solution
<p>16. Err – 1003 = Control valve motor ran too long and was unable to find the next cycle position</p>	<ul style="list-style-type: none"> a. Motor failure during a regeneration b. Foreign matter built up on piston and stack assemblies creating friction and drag enough to time out motor c. Drive bracket not snapped in properly and out of position enough that reduction gears and drive gear do not interface 	<ul style="list-style-type: none"> a. Check motor connections then Press NEXT and REGEN buttons for about 3 seconds to resynchronize software with piston position. b. Replace piston and stack assemblies. Press NEXT and REGEN buttons for about 3 seconds to resynchronize software with piston position. c. Snap drive bracket in properly then press NEXT and REGEN buttons for about 3 seconds to resynchronize software with piston position.
<p>17. Err - 14001 = Message queue full</p>	<ul style="list-style-type: none"> a. LEAD PC Board did not receive a response from LAG units. 	<ul style="list-style-type: none"> a. Press NEXT and REGEN buttons for > 3 seconds to resynchronize software with piston position.
<p>18. Err -15003 = MAV or NHWPB valve motor ran too long and unable to find the proper park position</p> <p>Motorized Alternating Valve = MAV</p> <p>No Hard Water Bypass = NHBP</p>	<ul style="list-style-type: none"> a. Control valve programmed for ALT A or NHWPB without having a motorized drive securely connected to the 2-pin terminal labeled “BYPASS” on the main PC Board b. Poor wire connection c. Excess drag causing timeout before stall d. Motorized Bypass or MAV for NHBP motor not fully engaged with reduction gears 	<ul style="list-style-type: none"> a. Press NEXT and REGEN buttons for about 3 seconds to resynchronize software with piston position. Re-program valve to proper setting b. Remove power and check connection for Motorized Bypass or MAV for NHBP motor to PC Board two pin connection labeled BYPASS. Make sure wires in connector are inserted securely and no wires are broken. Clean pins on PC Board by plugging and unplugging the connector a few times to remove excess protective coating. Press NEXT and REGEN buttons for about 3 seconds to resynchronize software with piston position. c. Open Motorized Bypass or MAV for NHBP to check for obstructions d. Properly insert motor into casing, do not force into casing. Press NEXT and REGEN buttons for about 3 seconds to resynchronize software with piston position.

Problem	Possible Cause	Solution
<p>19. Err – 15010 = Motorized Bypass or MAV for NHBP valve motor ran too short (stalled) while trying to drive off-line</p> <p>Motorized Alternating Valve = MAV</p> <p>No Hard Water Bypass = NHBP</p>	<p>a. Foreign material is lodged in Motorized Bypass or MAV for NHBP valve</p> <p>b. Mechanical binding</p>	<p>a. Open up Motorized Bypass or MAV for NHBP and check for foreign material. Press NEXT and REGEN buttons for about 3 seconds to resynchronize software with piston position.</p> <p>b. Check drive cap assembly or piston and seal/ stack assembly, check reduction gears, drive gear interface, and check Motorized Bypass or MAV for NHBP black drive pinion on motor. Press NEXT and REGEN buttons for about 3 seconds to resynchronize software with piston position.</p>
<p>20. Err – 15011 = Motorized Bypass or MAV for NHBP valve motor ran too short (stalled) while trying to drive online</p> <p>Motorized Alternating Valve = MAV</p> <p>No Hard Water Bypass = NHBP</p>	<p>a. Foreign material is lodged in Motorized Bypass or MAV for NHBP valve</p> <p>b. Mechanical binding</p>	<p>a. Open up Motorized Bypass or MAV for NHBP and check for foreign material. Press NEXT and REGEN buttons for about 3 seconds to resynchronize software with piston position.</p> <p>b. Check drive cap assembly or piston and seal/ stack assembly, check reduction gears, drive gear interface, and check Motorized Bypass or MAV for NHBP black drive pinion on motor. Press NEXT and REGEN buttons for about 3 seconds to resynchronize software with piston position.</p>

Problem	Possible Cause	Solution
<p>21. # of units error: Communications has been broken with the unit specified in the error message. These errors are logged as 16K series errors as follows: 16001: error with unit 2 16002: error with unit 3 16003: error with unit 4 16004: error with unit 5 16005: error with unit 6 16006: error with unit 7 16007: error with unit 8 16008: error with unit 9 16009: error with unit 10 160010: error with unit 11 160011: error with unit 12 160012: error with unit 13 160013: error with unit 14 160014: error with unit 15 160015: error with unit 16</p>	<p>a. System is programmed for the wrong number of units or a LAG unit is in "error # of units" mode due to loss of power.</p> <p>b. Poor connection on PC Boards</p> <p>c. More than one unit has determined that it is the LEAD unit</p>	<p>1) Correct all errors on LAG units before attempting to reset error on LEAD unit</p> <p>a. Pressing any button while in the # of units error will enter the user into the setting screen. Adjust to the correct units for the system and press NEXT to exit the setup screen. Press NEXT and REGEN buttons for about 3 seconds to resynchronize software with piston position. Re-program valve to proper setting.</p> <p>b. Make sure wires in connector are inserted securely and no wires are broken. Clean pins on PC Board by plugging and unplugging the connector a few times to remove excess protective coating. Press NEXT and REGEN buttons for about 3 seconds to resynchronize software with piston position.</p> <p>c. Press NEXT and REGEN buttons for about 3 seconds to resynchronize software with piston position. Then re-program each valve to operate as a single individual unit. Re-program the control that is to be the LEAD unit and it will filter down the programming to the LAG units automatically.</p>
<p>22. Err – 18000 = Reset was performed, this error code will display in the diagnostics under the error log</p>	<p>a. Reset performed.</p>	<p>a. You can view dates and times resets were performed</p>
<p>23. Err – 18001 = Power loss, this error code will display in the diagnostics under error log</p>	<p>a. When power is lost a signal is sent to log the power loss</p>	<p>a. You can view dates and times when power outage occurred</p>
<p>24. Err – 18002 = Power restored, this error code will display in the diagnostics under error log</p>	<p>a. When power is restored a signal is sent to log the power being restored</p>	<p>a. You can view dates and times when power outage occurred</p>

Problem	Possible Cause	Solution
25. Err – 20001 = AUX motor ran too long while trying to find proper park position.	<ul style="list-style-type: none"> a. Control valve programmed for NHBP or Separate Source without having a motorized drive securely connected to the 2-pin terminal labeled “AUX” on the main PC Board b. Poor wire connection c. Mechanical binding d. Motorized MAV for NHBP motor not fully engaged with reduction gears, should be flush top of gear cover. 	<ul style="list-style-type: none"> a. Press NEXT and REGEN buttons for about 3 seconds to resynchronize software with piston position. Then re-program valve to proper setting b. Remove power and check connection for MAV or NHBP motor to PC Board two pin connection labeled “AUX”. Make sure wires in connector are inserted securely and no wires are broken. Clean pins on PC Board by plugging and unplugging the connector a few times to remove excess protective coating. c. Press NEXT and REGEN buttons for about 3 seconds to resynchronize software with piston position. d. Properly insert motor into casing, do not force into casing twist while inserting. Press NEXT and REGEN buttons for about 3 seconds to resynchronize
26. Err – 20002 = AUX motor ran too long during unwind.	<ul style="list-style-type: none"> a. When Aux motor ran into stall it did not unwind to relieve the stress on the pistons position. 	<ul style="list-style-type: none"> a. Press NEXT and REGEN buttons for about 3 seconds to resynchronize software with piston position.
27. Err – 20011 = Motorized MAV or NHBP valve motor ran too short (stalled) while trying to drive online	<ul style="list-style-type: none"> a. Foreign material is lodged in MAV or NHBP valve b. Mechanical binding 	<ul style="list-style-type: none"> a. Open MAV or NHBP and check for foreign material. Press NEXT and REGEN buttons for about 3 seconds to resynchronize software with piston position. b. Check main drive assembly, remove motor and be sure white gear turns freely.
28. Err – 21xxx = System auto recovery from memory location errors	<ul style="list-style-type: none"> a. Memory location verifications were corrected 	<ul style="list-style-type: none"> a. You can view dates and times these occurred.

NOTES:

NOTES:

NOTES:

Revision History:

10/19/2022

Table of Contents:

Modified and adjusted page numbers

Page 4:

Modified/added 2HF information

Page 11:

Updated displays

Page 23:

EXPANSION SETUP 1 and 2A displays

Page 33:

Added Modbus information

Page 36:

WS2HF Drawing

Page 39:

Added reference to WS2HF

Page 45:

1	V3068-01	WS2H/3 POD FRONT/BACK COVERS	1
---	----------	------------------------------	---

updated callout #1

Page 40:

Added references to WS2HF

Page 46:

Updated table/combined pages

Page 47:

Added Inline Meter info

Page 48:

Header

Page 51:

Bases - added Upper Diffusers and WS2H/2QC Side Mount

Page 56:

Header

Page 57-64:

edits to content and formatting

12/13/2022

Various grammatical and formatting changes throughout.

Page 48:

Updated component table. Added information on WS3 Injector Tube.

Page 51:

Updated information on Side Mount Base.

Page 63:

Updated solution to items 23 and 24.

Page 64:

Updated problem and possible cause to item 26.